

EN

 **SCHNEESTERN**

action sports engineered



**Prices**  
on request

**SI / OW**  
EQUIPMENT



Action Sport is our DNA. But what does that mean, what is Action Sport? For us, it's that kind of sport that makes your heart beat faster and always gives you a bit of thrill. Action Sport is for individuals and that means that everyone can experience it in one's own way. That's why the first ride through the snow park can be as action-packed as the 100th jump at the X-Games.

Extremes, which aren't really any and yet determine our daily work. Our mission is to make action sports available for everyone, to bring it from the niche to the general public. Therefore, we use our know-how since 1999, therefore we go every day to the office, to the mountain, to the workshop or to the construction site – to make the sport we love safe and to embed it deeper into society on a long term. Regional as well as global.

How we do that? By bringing the knowledge of conventional engineering disciplines into an unusual environment. By not allowing ourselves to make any mistake in a world of freestyle and putting quality and safety always first. Action Sport is a trendsetter and an absolute term at the same time. A sport that used to be sneered at as a fringe sport has now become Olympic. Action Sport is more than just a trick. It is the physical and mental orientation towards a sporting experience.

We have recognized this development a long time ago and see in it the answer to the needs of our customers. We know about the positive effects of the sport and because we recognize ourselves in the joy of the first trick with the skateboard, bike, snowboard or freeskiiing. Detail moments that for us once again sharpen the view of the bigger picture: To embed SNOW, BIKE, SKATE and WAKE deeper into our society. Because we believe in it and because we can:

**Action Sports engineered!**



1. Safety..... 6

2. Customer Service..... 8

3. Delivery.....9

4. Product categories:

**Freestyle Obstacles ..... 12-15  
for Skischools**

**Funline ..... 16-39**

**Attraction ..... 40-63**

**Freestylepark ..... 64-109**

**Add Ons ..... 110-117**

5. Contact ..... 119



# Better safe than sorry!

Action sports in winter is next to our summer product segments bike, skate and wake and a big part of what we do at Schneestern.

Since 1999 we produce professional snowpark equipment in Germany. But for the global market and that is how already more than 15.000 obstacles have been produced here. From a downrail for freeskiers to the High Five with sound for "John Doe" - we offer modern action sports products for winter sports.



In order to let snowparks and the necessary equipment take root in winter sports, safety has always been our priority number one.

However, to talk about safety in action sports is one thing, to prove it the other. In addition to the Schneestern quality checks, by the way we are the only action sport company who does that - our products, as well as our production site undergo since 2008 an independent quality and safety inspection by the TÜV Süd. But before we even think about putting the Schneestern quality and the TÜV Süd badge on our products, we have three separate quality checks.

That's how we make sure that all of our products meet our high safety requirements and live up to the responsibility we have towards your guests. Only safe products allow one wide acceptance and further development of action sports.

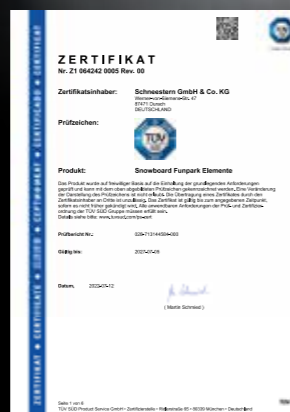

## Made in Germany

We bank on Germany as a production location! In our 5000 m<sup>2</sup> production hall, located in the southern Allgäu, we produce action sports equipment up to the highest quality standards. Of course, we rely on reliable and predominantly regional supplier network.



## Developed in Germany

The times when had put a „simple rail“ in a snowpark and the job was done, are long gone. Just like in „regular“ engineering industries we also rely on a standardized and sustainable product development. This is ensured by our in-house engineering team, which designs all products precisely with SolidWorks and leaves nothing to chance.



## Made to last - Product tests

For our customers it is nothing new under the sun. Products in winter sports resorts often have to endure harsh and extreme conditions. May it be because of high wear by the guests or nature itself. For that reason and because safety is our top priority, we leave nothing to chance and test our products intensely before we ship them to you. How we do that? With our own test laboratory incl. a cooling chamber!



# Technical customer service

360 degree concepts play a vital role in our company philosophy. A holistic support of our customers is very important for us. That's why we have the world's first customer service in the action sports industry. It is the last piece in our service chain. 24h-hotline and an on-site service guarantee a consistent quality, even if the usage and complexity of our products increase.



## OUR SERVICES:

- On-site service
- Technical support for all kind of problems
- Build-up support for all technical products
- Repairs
- Replacement and maintenance service for all SST products
- Stocktaking and documentation of all damages after each season
- Europe-wide service
- Price on request or fixed service rate



**SERVICEHOTLINE: +49 831 960 886 56**

# Worldwide delivery



Whether your resort is in China or on a glacier in the alps. Just by our projects and the demands of our customers in the last 20 years we for our part have become logistics experts. That's way we deliver all of our products worldwide. You want to have snowpark obstacle in your resort? We and our selected logisitc network deliver it directly on the slopes.

# Product features



**Sound effects:** That's where the music plays. This product entertains your guests with interactive sound effects.



**Light effects:** Something for your eyes. Interactive light effects light up your day.



**Wear parts:** These products are subject to usage-related wear



**RAL-colors:** These products can be ordered in all RAL-colors.



**Branding options:** These products can be branded individually.



**Individualization:** It's your product, so it can look the way you want it to.

**Profile:** Not all obstacles are the same. You can have the same geometry with different profiles. More on page 68.



Box



Butterbox



Postbox



Pipe



Industry

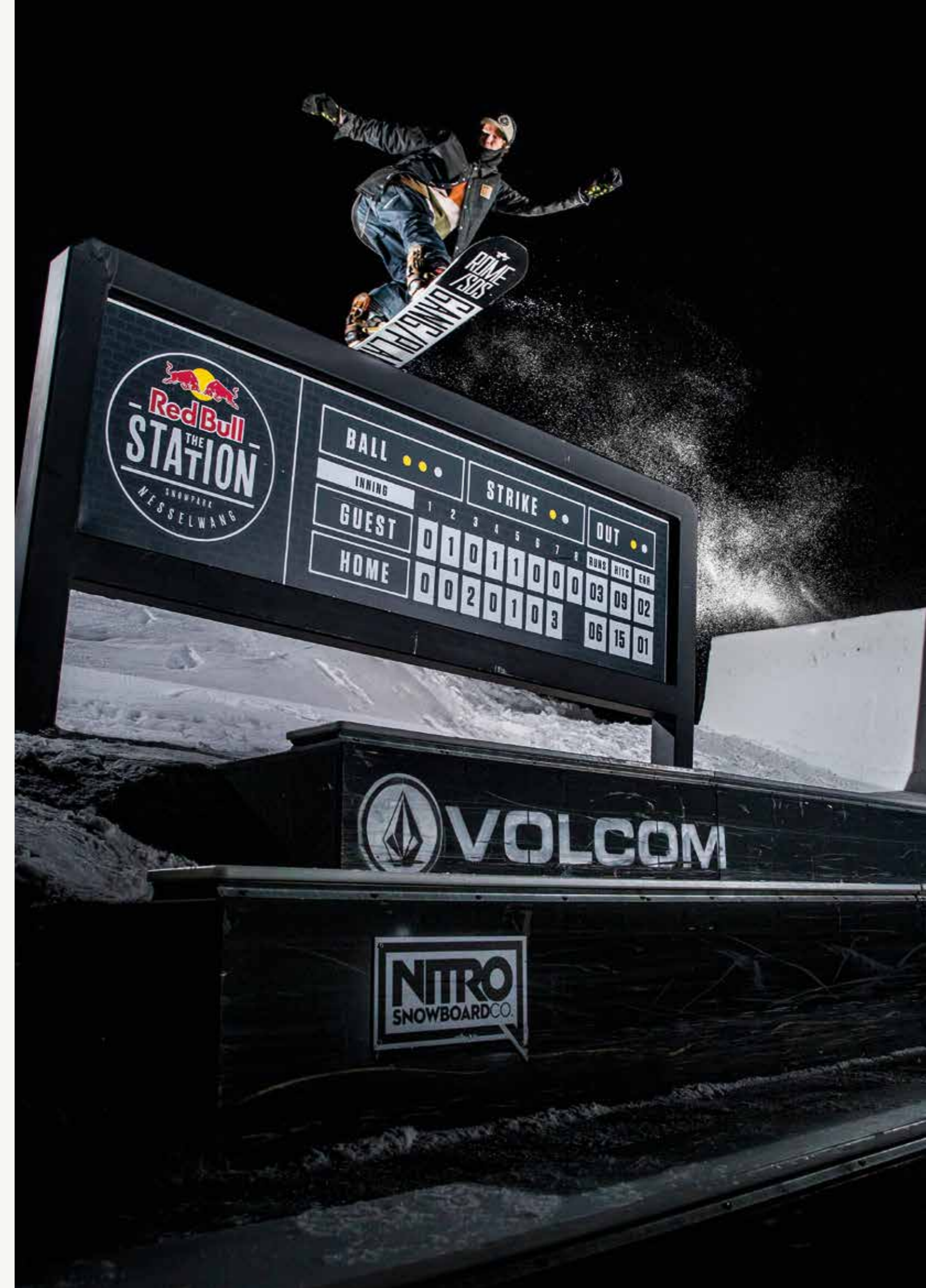



# Freestyle Obstacles for Ski Schools

At the beginning of the millennium snowparks where “a brand-new thing” and so from the original idea new concepts quickly began to emerge. Snowparks, specifically tailored to the needs of other target groups. Snowparks are now mainstream and therefore a foundation needs to be laid.

With our freestyle obstacles for ski schools, exclusively for our partner Sunkid, we want to support the youngest of all snowpark users.

For the young generation of winter sports guests snowparks are a matter of course and we are happy that by developing the Kids obstacles we can help this target group to find their way into the world of action sports.



## BENEFITS FOR SKI SCHOOLS

- creative and diverse way to organize ski school lessons
- safe option to introduce kids to snow parks
- No experience in building a snowpark necessary
- no kickers needed - just little snow ramps

## SUPPORT FOR THE KIDS

- Fun learning
- Scouting of young talents
- Support of the individual development and creativity
- Building the courses together promotes social behavior and motor abilities
- Ramps with a didactic concept - quick sense of achievement





# Methodical learning beam

Concept and goals

Gradually reduce the contact/sliding surface

Preparation for „bigger“ obstacles as well as for finding you around in „real“ snowparks

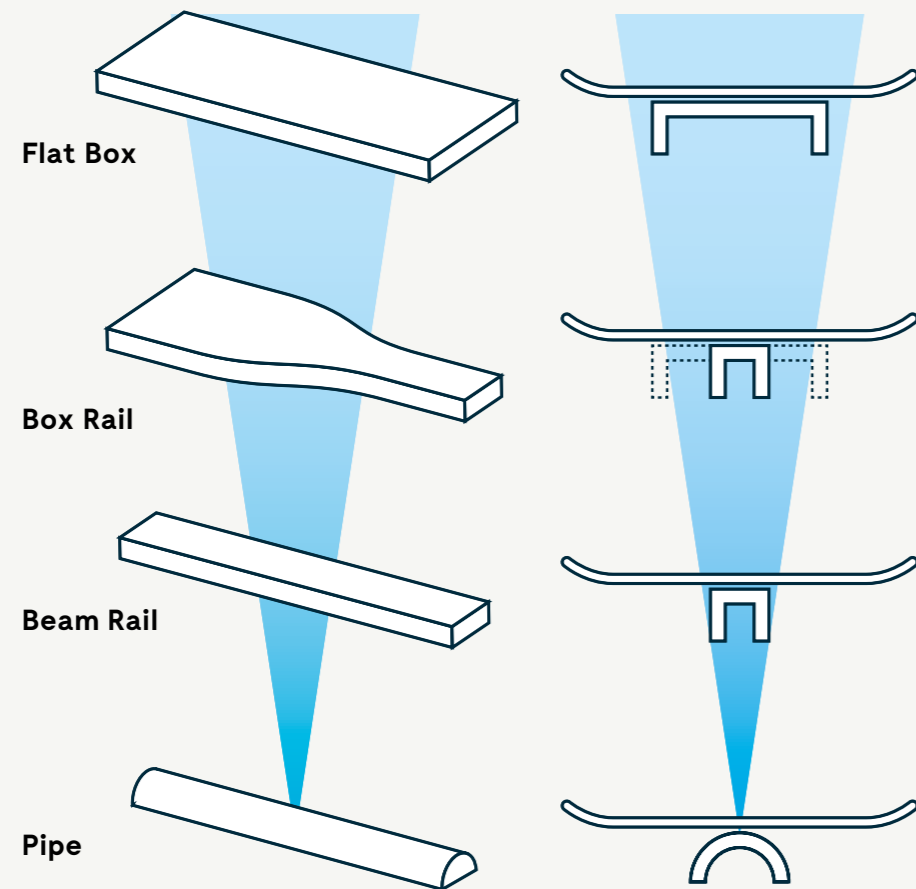

SLIDE PLATE



SLOPE FLAT



SLOPE RAINBOW



SLOPE UP & DOWN



BOX RAIL



PIPE



RATTLEKICKER



KICKER



KICKER SHUTTER



## PRODUCT FEATURES

- No sharp edges on the surface
- Possibility to combine the ramps individually
- Safe anchoring in the snow
- Easy handling through recessed grips
- Easy to transport and store
- Overall construction made of plastic





FUNLINE



# Application

## Funline

The name says it all – The Funline is all about fun. The combination of various obstacles such as modular snow tunnels, Sound High Five, Funline Rainbow Bridge & Co. make sure that every meter of the course is pure fun. The course is always designed like a Cross course – a clear line and in a way that you get your money's worth of fun. There hardly isn't an easier and more fun way to get from top to bottom in a winter sport resort.

- Target groups:**
- Kids
  - Recreational skier/snowboarder
  - Alpine riders
  - Freestyle beginners



SOUND HIGH FIVE



ROTARY CHARACTER



MODULAR TUNNEL



FUNLINE FLATBOX XL



BONK

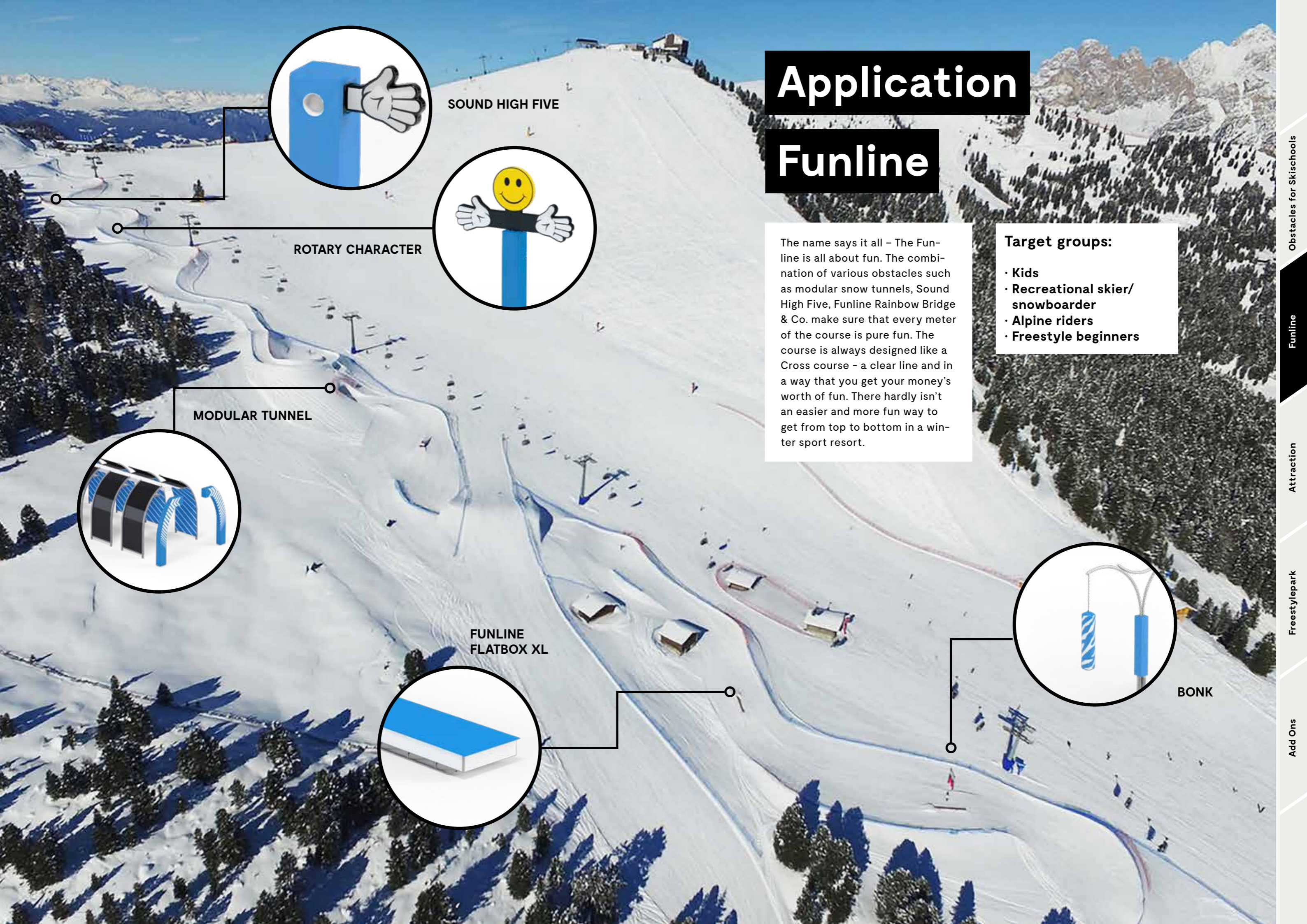



## FUNLINE FLATBOX XL

Order-Nr. KBFL5XL

Size: 5 x 1,5 x 0,4 (l x w x h)



Profile: One piece butter box XL  
 Material: hot zinc dipped steel frame  
 Side panelling: 4mm Dibond- white- riveted  
 Slide surface: 15mm PE- standard color: white- screwed from below

Coloured sliding surface on request possible

One Piece Butter Box

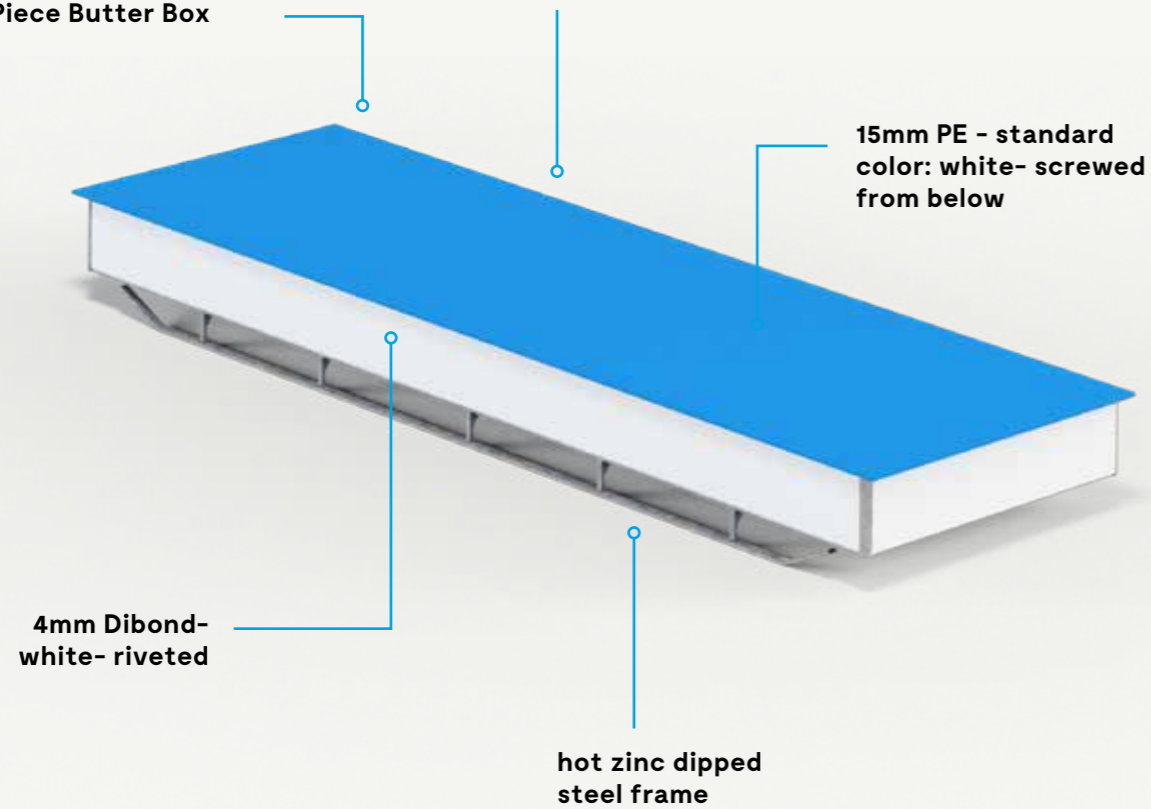

## FUNLINE FLATBOX XL PT

Order-Nr. KBFL5XLPT

Size: 5 x 1,3 x 0,4m (l x w x h)



Material: hot zinc dipped steel frame  
 Side panelling: 4mm Dibond incl. laminated digital print  
 Slide surface: 19mm Playtec e.g. blue - yellow - blue  
 Profile: One piece butter box XL



UV resistant



no corrosion



no screws

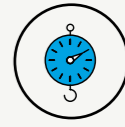

lightweight

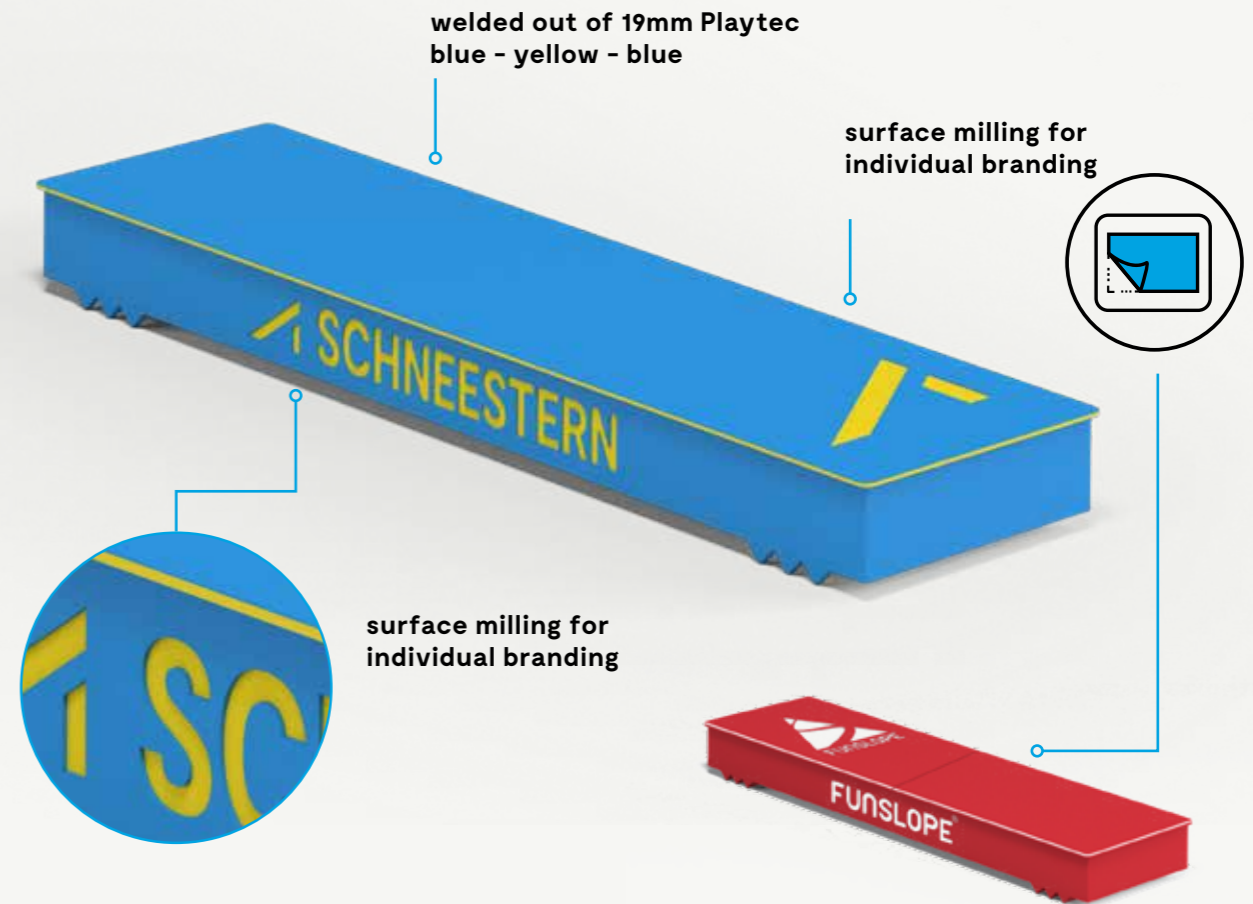

## FUNLINE UP & DOWN BOX XL

Order-Nr. KBUD5XL

Size: 5 x 1,5 x 0,5 (l x w x h)

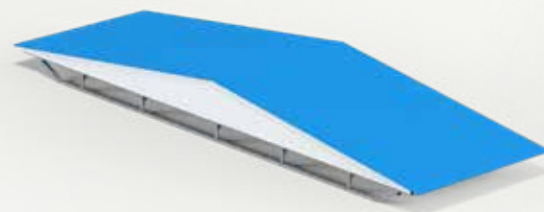

## FUNLINE RAINBOW BOX XL

Order-Nr. KBRA5XL

Size: 5 x 1,5 x 0,5 (l x w x h)

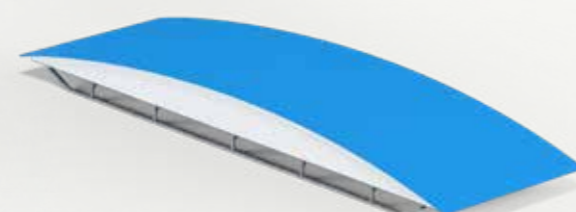

## FUNLINE UP & DOWN BOX XL PT

Order-Nr. KBUD5XLPT

Size: 5 x 1,3 x 0,4m (l x w x h)



## FUNLINE RAINBOW BOX XL PT

Order-Nr. KBRA5XLPT

Size: 5 x 1,3 x 0,4m (l x w x h)

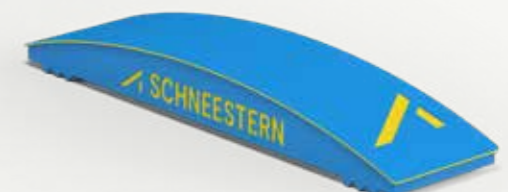



# SPEED BOOSTER

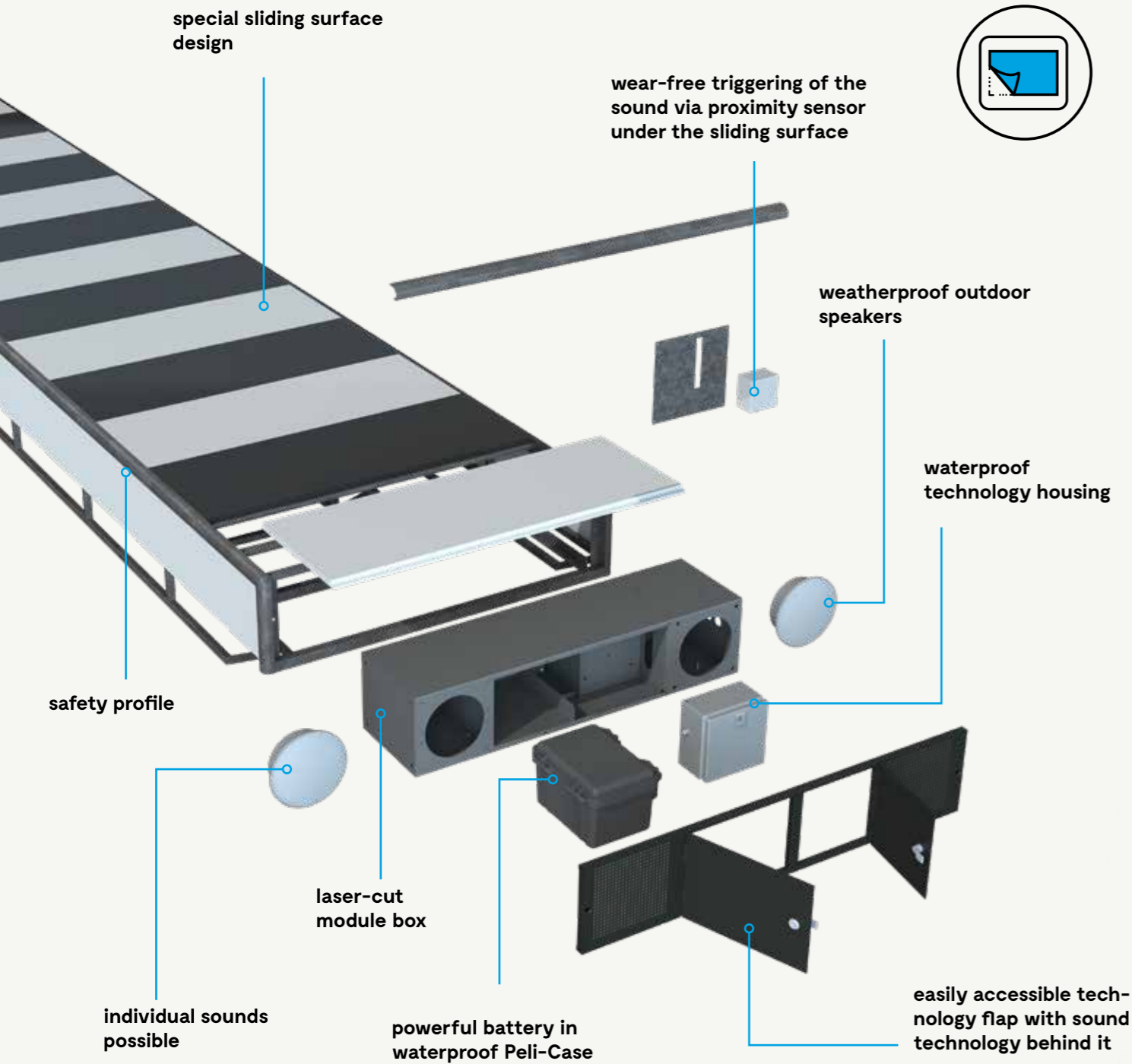

## SPEED BOOSTER

Order-Nr. SPEEDBOOSTER

Size: 6 x 1,27 x 0,25m (l x w x h)



Profile: One piece butter box XL  
 Material: hot zinc dipped steel frame  
 Side panelling: 4mm Dibond on both sides- black- riveted  
 Slide-surface: 20mm PE, milled-out and put in  
 Color: white/ black, white/ blue, blue/ black (photo p. 25)  
 Accessory: Sound modul incl. radar sensor, control box, MP3 Player and outdoor boxes (45 watt each), incl. battery and charger

## BOOST KICKER

Order-Nr. BOOSTKICKER

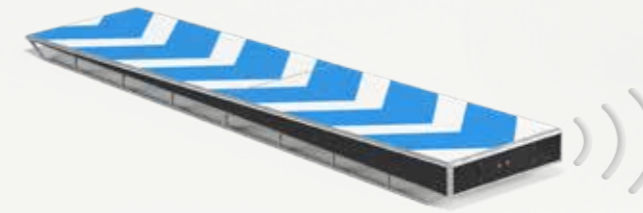

Size: 4,82 x 1,27 x 0 - 0,25m (l x w x h)



Profile: One piece butter box XL  
 Material: hot zinc dipped steel frame  
 Side panelling: 4mm Dibond on both sides- white- riveted  
 Slide-surface: 20mm PE, milled-out and put in  
 Color: blue/ white, black/ white, black/ blue  
 Accessory: Sound modul incl. radar sensor, control box, MP3 Player and outdoor boxes (45 watt each), incl. battery and charger

## CROSS WALK

Order-Nr. CROSSWALK



Size: 6 x 1,27 x 0 - 0,25m (l x w x h)



Profile: One piece butter box XL  
 Material: hot zinc dipped steel frame  
 Side panelling: 4mm Dibond on both sides- black- riveted  
 Slide-surface: 20mm PE, milled-out and put in- color: black/ white  
 Accessory: Crosswalk sign, sound modul incl. radar sensor, control box, MP3 Player and outdoor boxes (45 watt each), incl. battery and charger

## SOUND BOX

Order-Nr. SOUNDBOX

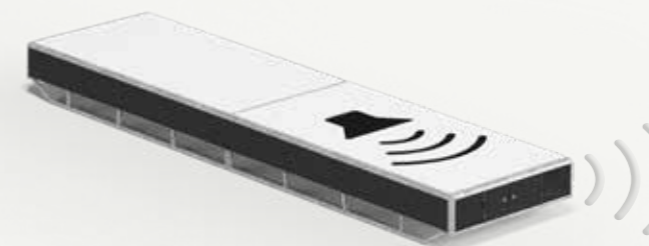

Size: 5 x 1,27 x 0,25m (l x w x h)



Profile: One piece butter box  
 Material: hot zinc dipped steel frame  
 Side panelling: 4mm Dibond on both sides- black- riveted  
 Slide-surface: Playtec, milled-out, color: white/ black  
 Accessory: Sound modul incl. radar sensor, control box, MP3 Player and outdoor boxes (45 watt each), incl. battery and charger

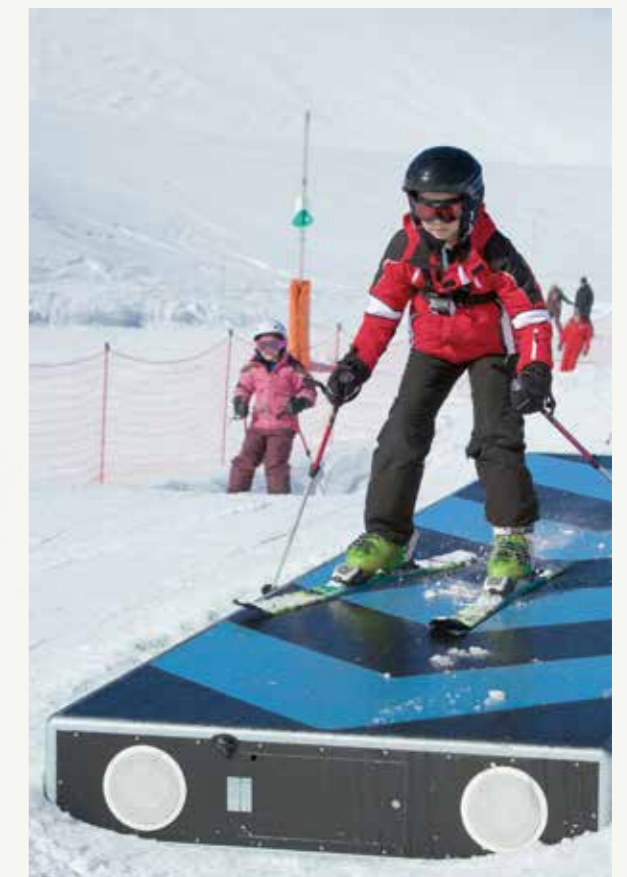



## KICKERBANK

Order-Nr. KICKERBANK



Size: 3 x 1 x 0,5m (l x w x h)



Profile: One piece butter box  
 Material: hot zinc dipped steel frame  
 Side panelling: 4mm Dibond- white- riveted  
 Slide-surface: 20mm PE- blue- blind screwed  
 Extras: multi functional butter obstacle, can be used as bank, kicker, butterbox, wallride

## HANDYBOX

Order-Nr. Handybox

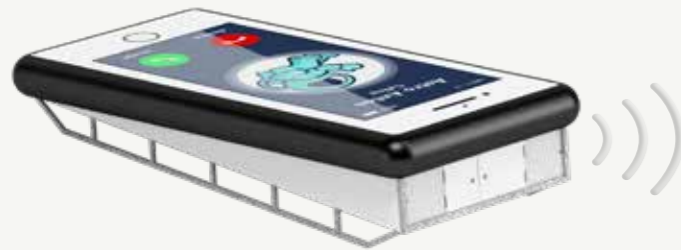

Size: 3m x 1,3 x 0,4m (l x w x h)



Profile: One piece butter box XL (Icon)  
 Material: hot zinc dipped steel frame  
 Slide surface: 8mm SKG- printed- glued to substructure  
 Accessory: Sound modul incl. radar sensor, control box, MP3 Player and outdoor boxes (45 watt each), incl. battery and charger

## RAINBOW BOOSTER

Order-Nr. RAINBOWBOOSTER

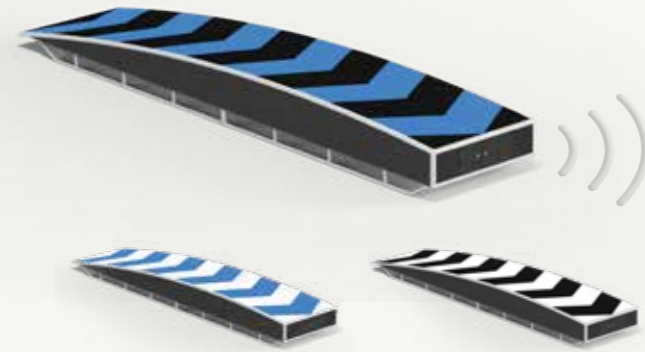

Size: 6 x 1,27 x 0,2 - 0,65m (l x w x h)



Profile: One piece butter box (Icon)  
 Material: hot zinc dipped steel frame  
 Side panelling: 4mm Dibond on both sides- black- riveted  
 Slide-surface: 20mm PE, milled-out and put in  
 Color: white/ black, white/ blue or blue/ black  
 Accessory: Sound modul incl. radar sensor, control box, MP3 Player and outdoor boxes (45 watt each), incl. battery and charger

## WAVE SPINE FUNTUBE

Order-Nr. FT 1/3 1,5-3



Size: 3m long



Material: 1,5m ø PE tube split in thirds  
 Standard color: light-blue  
 Accessories: incl. end panels and carrying handles

## RATTLEKICKER

Order-Nr. RK3



Size: 3 x 0,75 x 0,35m (l x w x h)



Profil: One Piece Butter Box  
 Material: 15mm PE blue



## FUNLINE FLATBRIDGE

Order-Nr. FLFLBRIDGE

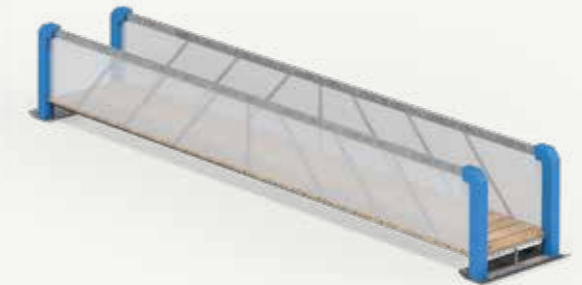

Size: 8 x 1,3 x 1m (l x w x h)



Profil: One Piece square tube flat bridge  
 Material: varnished steel, all standard RAL colors feasible without surcharge  
 Side panelling: polycarbonate, WPC planks in the middle  
 Extras: tubes padded with unicolor protection pad

## FUNLINE RAINBOW BRIDGE

Order-Nr. FLRABRIDGE



Size: 8 x 1,3 x 1m (l x w x h)



Profil: One piece square tube rainbow bridge  
 Material: varnished steel, all standard RAL colors feasible without surcharge  
 Side panelling: polycarbonate, WPC planks in the middle  
 Extras: tubes padded with unicolor protection pad



# SOUND HIGH FIVE

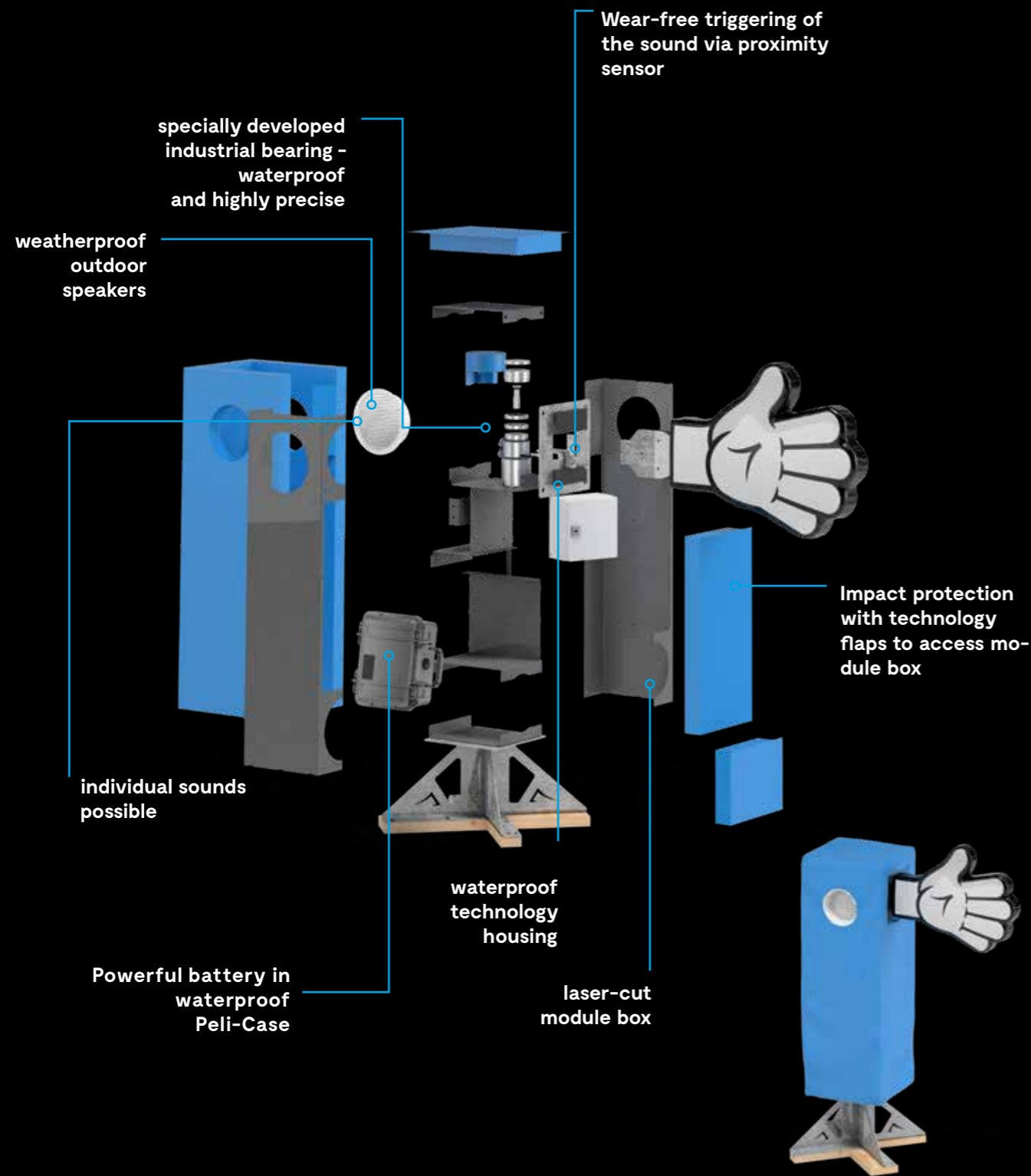

## SOUND HIGH FIVE

Order-Nr.: SHF

Size: 1,18 x 0,42 x 0,42 (h x w x d),  
size of the hands: 0,6 x 0,4m

Material: foam on steel construction, rotary by specially developed industrial bearing  
Color: pad covered with printed tarp  
Extras: sound modul incl. inductive sensor, control box, MP3 Player and outdoor boxes (45 watt each), incl. battery and charger



## SOUND ROTARY CHARACTER

Order-Nr.: SOUNDREHFIGUR



Size: 2,2 x 0,42 x 0,42 (h x w x d),  
size of the hands: 0,5 x 0,3m



Material: foam on steel construction, rotary by specially developed industrial bearing  
Color: pad covered with printed tarp  
Extras: sound modul incl. inductive sensor, control box, MP3 Player and outdoor boxes (45 watt each), incl. battery and charger

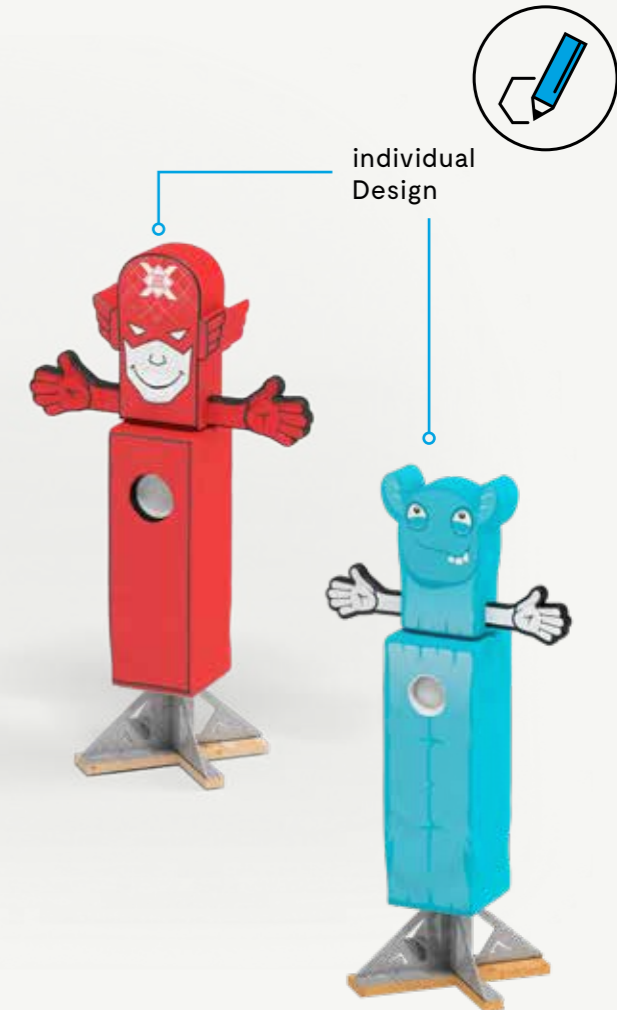

## GATE

Order-Nr.: SHF-individualisiert

Sound High Five

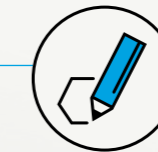

Size: 2,2 x 0,42 x 0,42 (h x w x d),  
size of the hands: 0,5 x 0,3m



Material: foam on steel construction,  
Color: pad covered with printed tarp  
Extras: sound modul incl. inductive sensor, control box, MP3 Player and outdoor boxes (45 watt each), incl. battery and charger





# HIGH FIVE

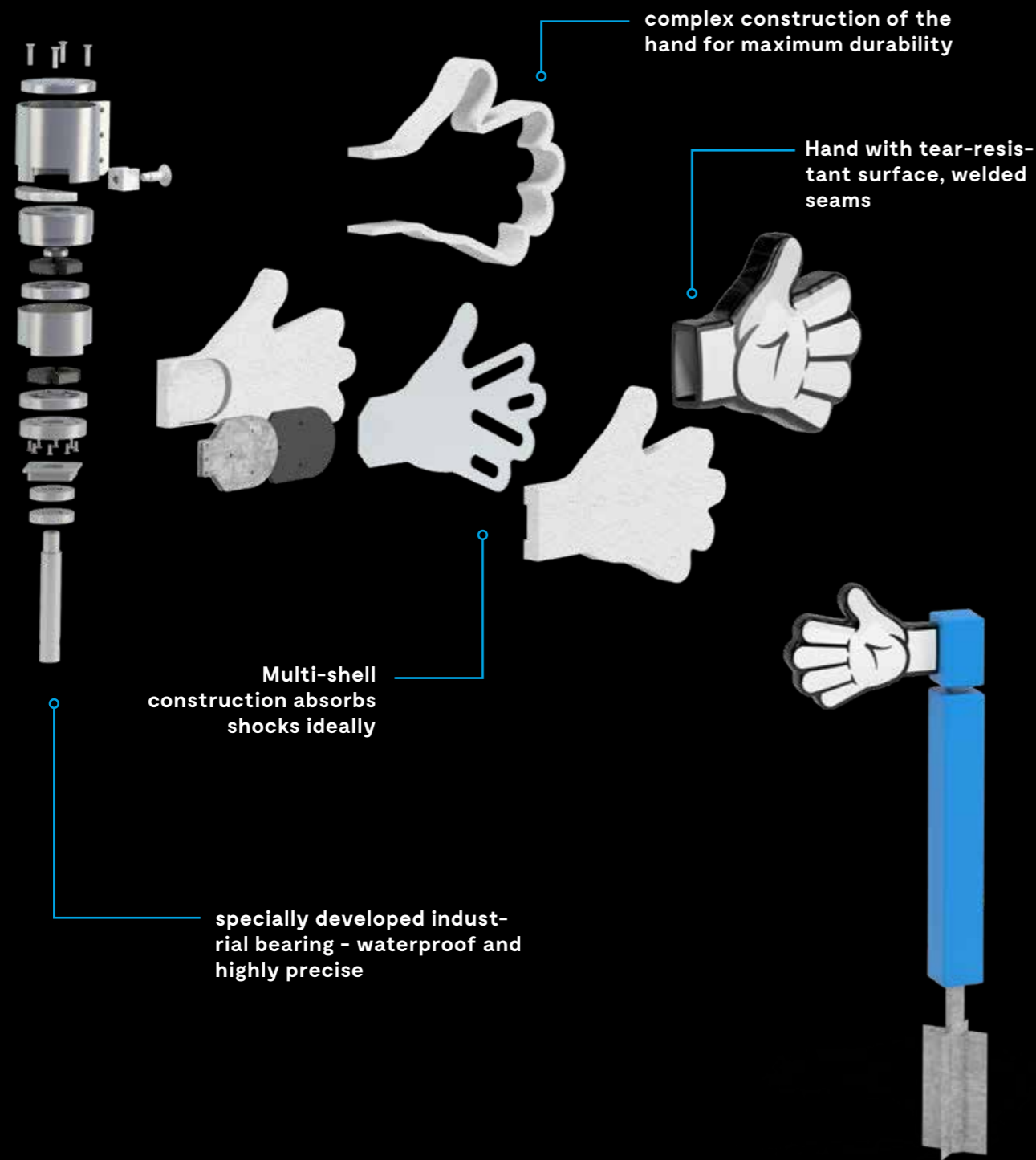

## HIGH FIVE

Order-Nr.: HIGHFIVE

Size: 1,36 x 0,18 x 0,18 (h x w x d),  
size of the hand 0,6 x 0,4



Material: PE foam hand for making high fives coated with printed tarp, protection pad also coated with printed tarp  
rotary by specially developed industrial bearing

## LOW FIVE

Order-Nr. LOWFIVE



Size: 0,56 x 0,18 x 0,18 (h x w x d),  
size of the hand 0,6 x 0,4m



Material: PE foam hand for making high fives coated with printed tarp, protection pad also coated with printed tarp  
rotary by specially developed industrial bearing

## ROTARY CHARACTER

Order-Nr. DREHFIGUR



Size: 1,8 x 0,42 x 0,18m (h x w x d),  
hands around 0,5 x 0,3m



Material: foam covered with printed tarp on steel construction  
Color: 10 RAL colors feasible for protection pad, Hand for making high fives coated with printed tarp,  
Extras: with industrial bearing, hands and head rotate

## BONK

Order-Nr. BONK



Size: 4,2 x 2,5m (h x w), 1-parted



Material: PE foam punching bag on hot zinc dipped steel frame and rope  
Color: 10 RAL colors feasible for punching bag and protection pad on pole  
Accessory: incl. snow anchor

## DOUBLEBONK

Order-Nr. DOUBLEBONK



Size: 4,2 x 2,4m (h x w)

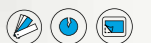

Material: PE foam punching bag on hot zinc dipped steel frame and rope  
Color: 10 RAL colors feasible for punching bag and protection pad on pole  
Accessory: incl. snow anchor



# PENDELUM

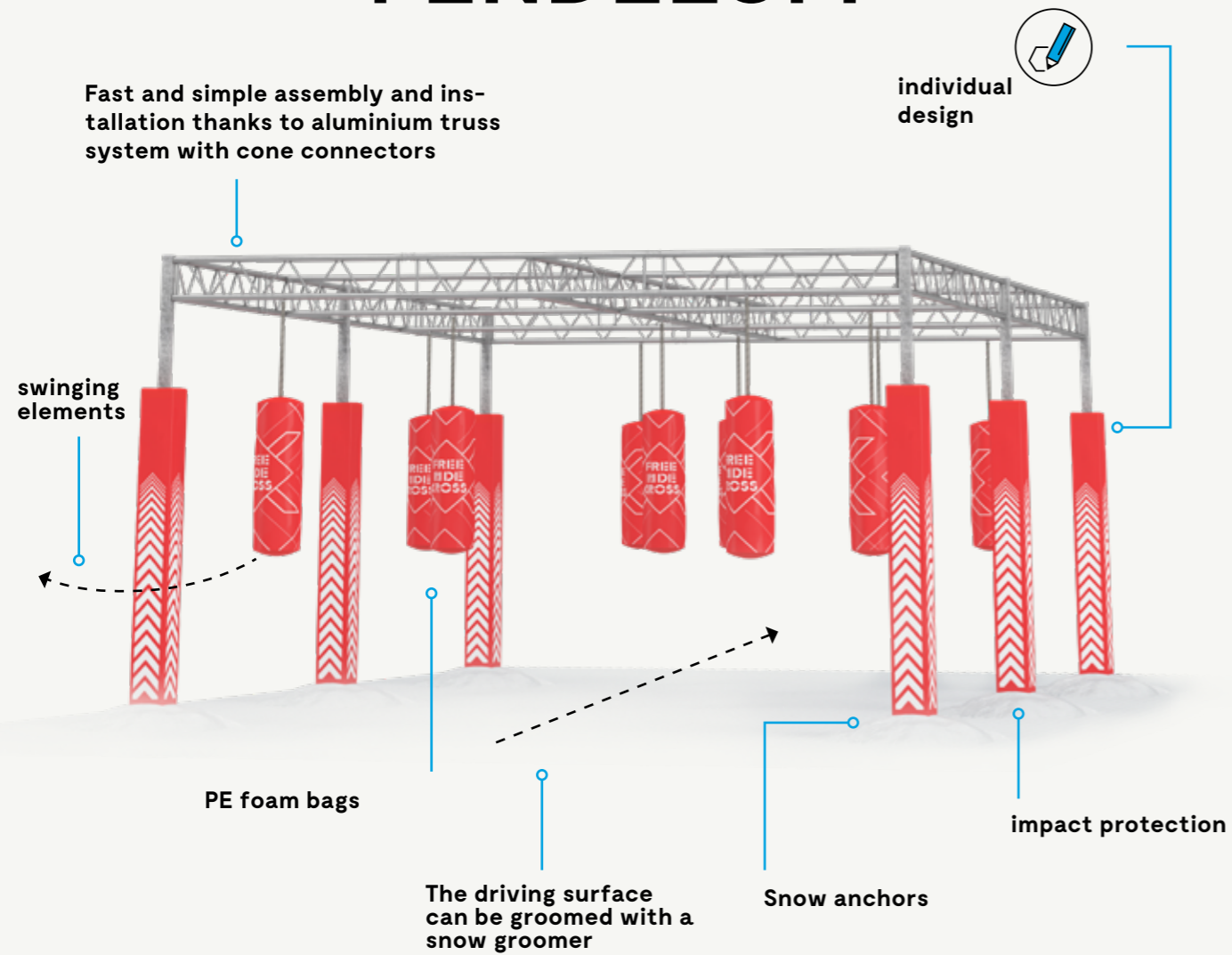

## PENDELUM

Order-Nr.: PENDELUM

Size: 3,5 x 6 x 8 m (h x w x l)

Material: Truss construction, PE foam bags and other hanging elements hung from the construction with steel ropes

Accessory: incl. snow anchors and protection pad on stilts



## XYLOPHON

Order-Nr.: XYLOPHON

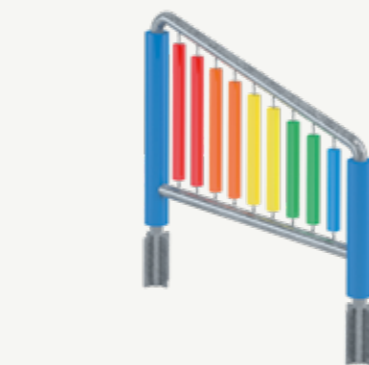

Size: 3 x 2,5m (w x h)

Material: hot zinc dipped steel frame, powdercoated aluminium pipes on chains

Color: 10 RAL-colours feasible for the protection pad  
Accessory: incl. snow anchor and protection pad on the stilts

## TREE BONK

Order-Nr.: TREEBONK



1,3m x Ø 0,3m

Multi-part set to hang an element e.g. from two trees  
Material: PE foam punching bag, bonks or other hanging elements hung from steel ropes and wheels to lock

## BULLS EYE

Order-Nr.: BULLSEYE



Size: 2m high, 1m ø

Material: PE foam target on hot zinc dipped steel pole  
Accessory: incl. snow anchor and protection pad on pole covered with printed tarp

## SOUND BULLS EYE

Order-Nr.: SOUND BULLSEYE



Size: 2,2 x 0,42 x 0,42 (h x b x t),  
Target: 2m high, 1m ø

Material: foam on steel construction, rotary by magnetic mechanism  
Color: pad covered with printed tarp  
Extras: sound modul incl. inductive sensor, control box, MP3 Player and outdoor boxes (45 watt each), incl. battery and charger



# MOUSE HOLE

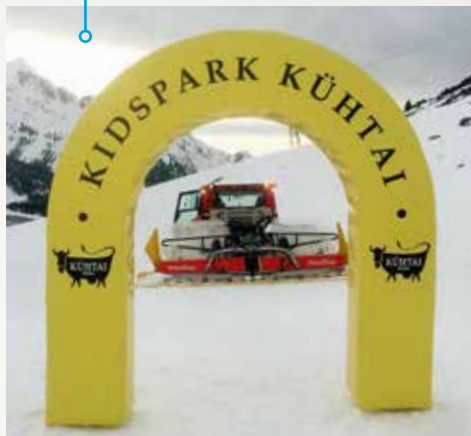
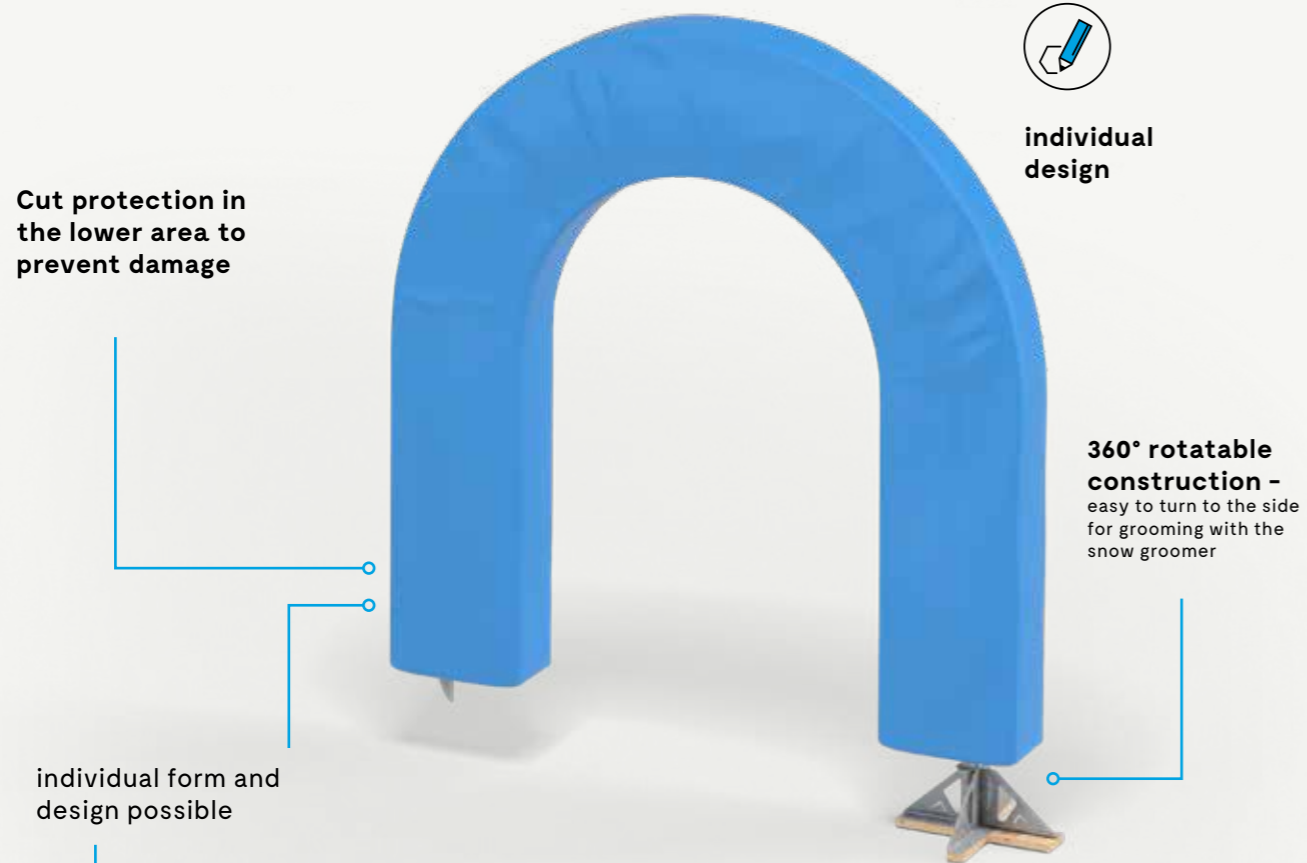

**MOUSE HOLE**  
Order-Nr.: MOUSEHOLE

Size: 2,46 x 2,48m (w x h)

Material: hot zinc dipped steel construction padded with protection pad, pad covered with printed tarp, Accessory: Snow anchor, rotary by 360°

Easy maintenance with the snow groomer 360°

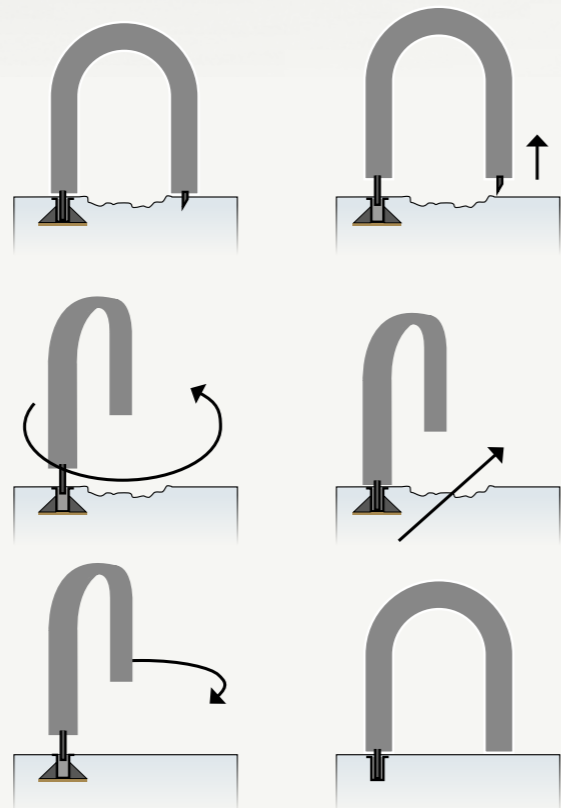

# HOOP RACE

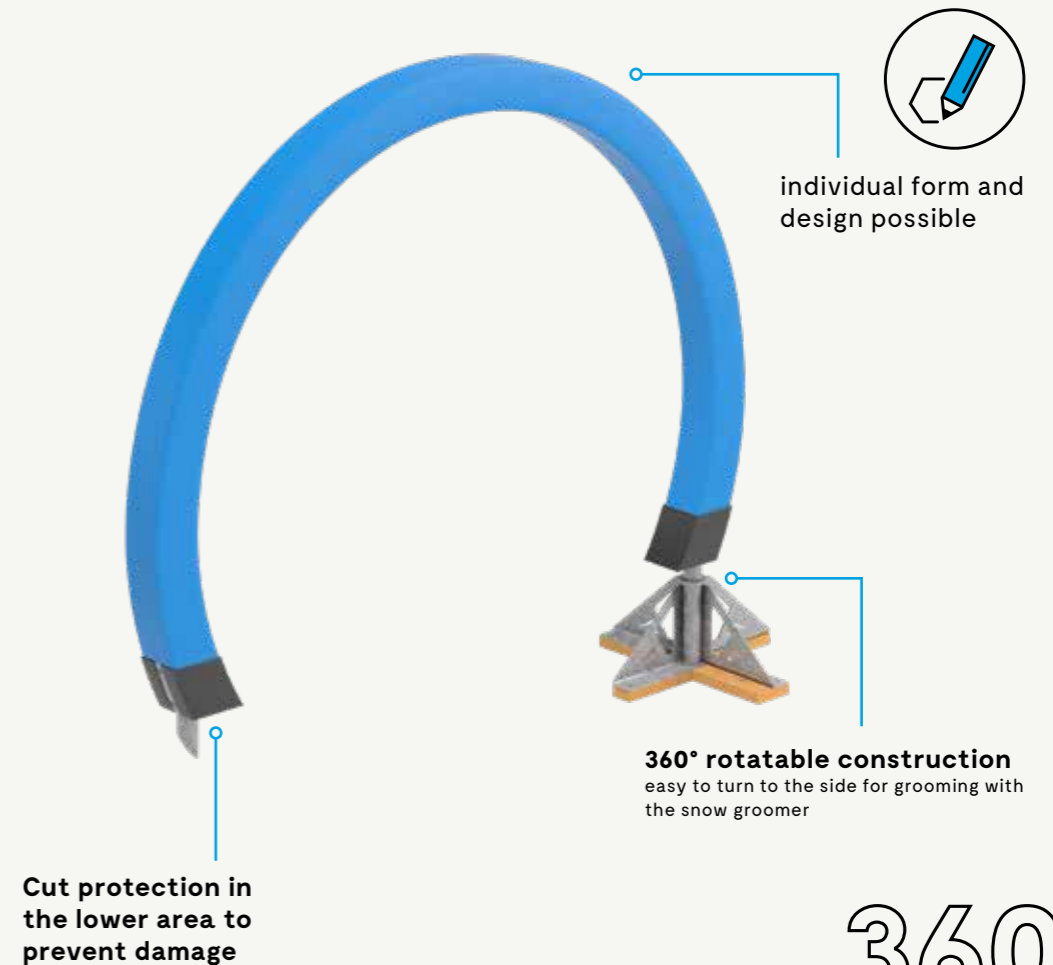

**HOOP RACE**  
Order-Nr.: HOOPRACE

Size: 2m ø

Material: hot zinc dipped steel construction padded with protection pad, pad covered with printed tarp



## WOOD DROP

Order-Nr. WOODDROPLAT



Size: 5 x 5 x 0,8-1,3 m (l x b x h)

Material: wooden construction made from spruce  
Panelling: planked with larch, paneled with planks on the inside, front & sides not panelled

## A-FRAME WOOD DROP

Order-Nr. WOODDROPAF



Size: 5 x 5 x 0,8-1,5 m (l x b x h)

Material: wooden construction made from spruce  
Panelling: planked with larch, paneled with planks on the inside, front & sides not panelled



## STAIRWAY

Order-Nr. STAIRWAY

Maße: 6m x 1,25m (L x b)

Material: hot zinc dipped steel frame, varnished wooden stairs  
Side panelling: Polycarbonate  
Accessory: stair element 4m long with black PE edge protections

hot zinc dipped steel construction with runners for transport

deceptively real escalator look

Side panels made of transparent, impact- and break-resistant plastic

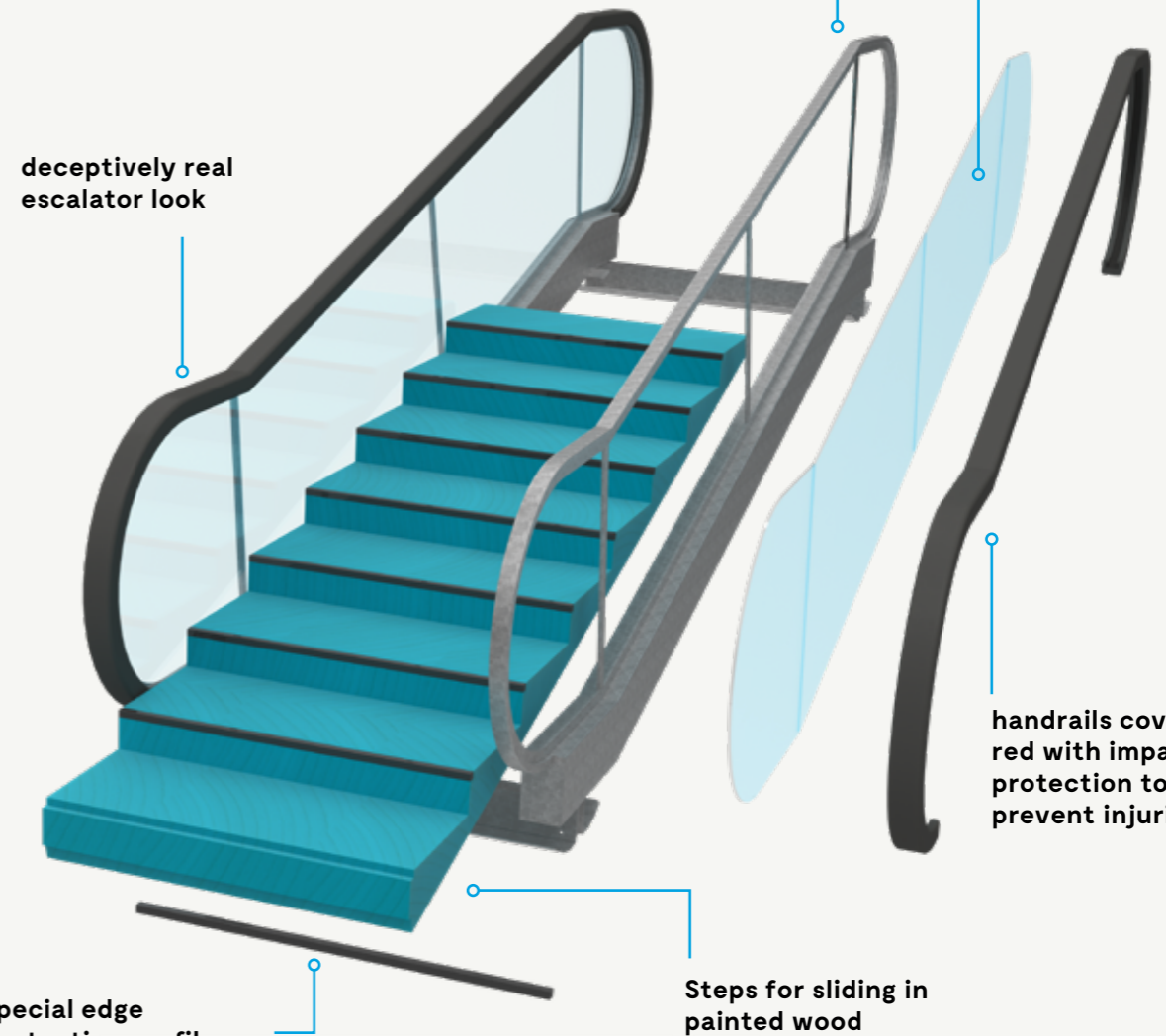

special edge protection profile on each step to minimize wear

Steps for sliding in painted wood





# Custom Made

Every action sports park is individual, just like you and your customers. Fits perfectly together? We think so too! That is why we offer the possibility to brand every snowpark individually in compliance with the customers CD. The individual elements of a snowpark are perfect as branding options. But that is not enough for us, we go one step further and offer you the possibility to create our own theme world in order to stand out. Only your fantasy is the limit and your guests will be amazed when they enter your own snowpark theme world.

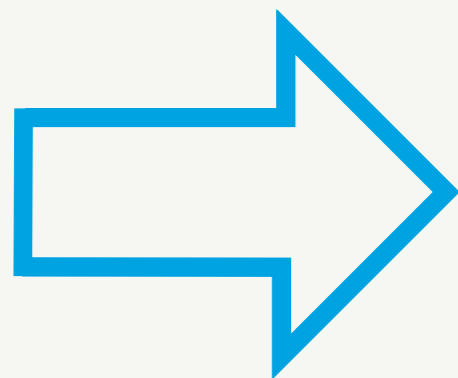
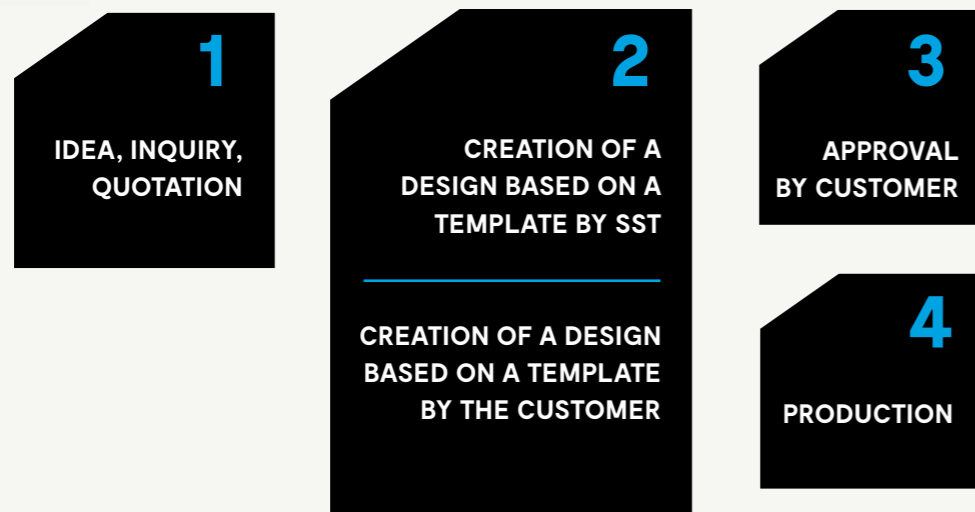

your individual Schneestern product

**Ice Tea**

- ENTRANCE ARCH
- ICE TEA FUNLINE
- MODULAR TUNNEL
- HIGH FIVE
- BONK

**Astro**

- BONK
- FRX
- SPEED CHECK
- ENTRANCE TOWER
- STARTGATE
- SOUND ROTARY CHARACTER
- BULLSEYE

**Eagle**

- CURVEPYLON
- BULLSEYE





ATTRACTION



# MODULAR TUNNEL

Simple handling, flexibly expandable, individual branding and sound / light effects which fascinate your guests - our modular tunnel combine all these characteristics. Based on the concept of the Schneestern modular system from snowparks, there are few products in our assortment being that flexibly shapeable whilst being such entertaining.



## ⊕ BENEFITS

- individual branding (inner zone and formwork)
- flexibly expandable
- easy and space-saving to store
- simple installation without tools
- easy handling
- Fast exchange of damaged single parts
- TÜV Süd approved and certified





# Modular Tunnel

## 1 MODULAR TUNNEL BASIC ELEMENTS



## 2 LIGHT AND SOUND

- » Triggering via radar sensor inside the tunnel
- » Choice of battery or mains supply operation



statically tested overall construction - suitable for crossing over with a snow groomer

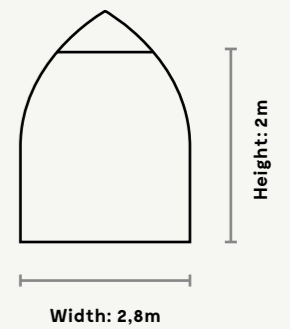

inside covered with 3mm Dibond

hot zinc dipped steel construction

conclusive connection between the elements by bolts

easy installation without tools

integrated cold insulation prevents snow from thawing away

## 3 FORMWORK

- individual design possible
- form is freely selectable within the template
- helps to create the crossing width with less snow



## 4 BRANDING

- all-over digital print with scratch resistant protective laminate
- about 50sqm branding area in the inner zone of a 10m tunnel



Outer dimensions max.: 3 x 3m (w x h),  
Passage: 1,87 x 2,15m (w x h)

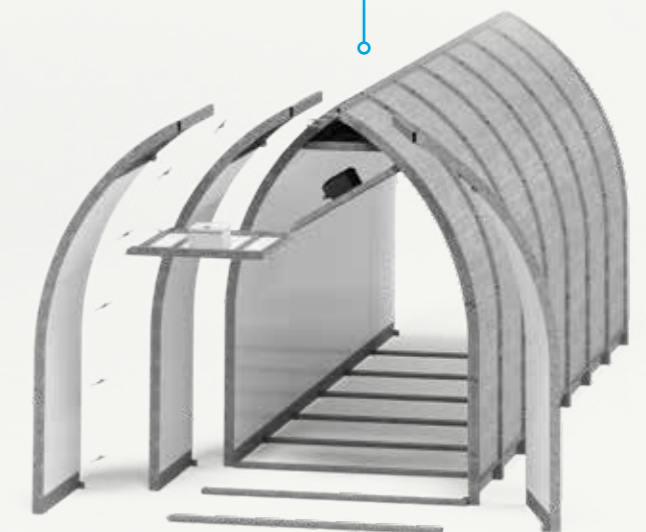



# Product features

## Modularity / Construction

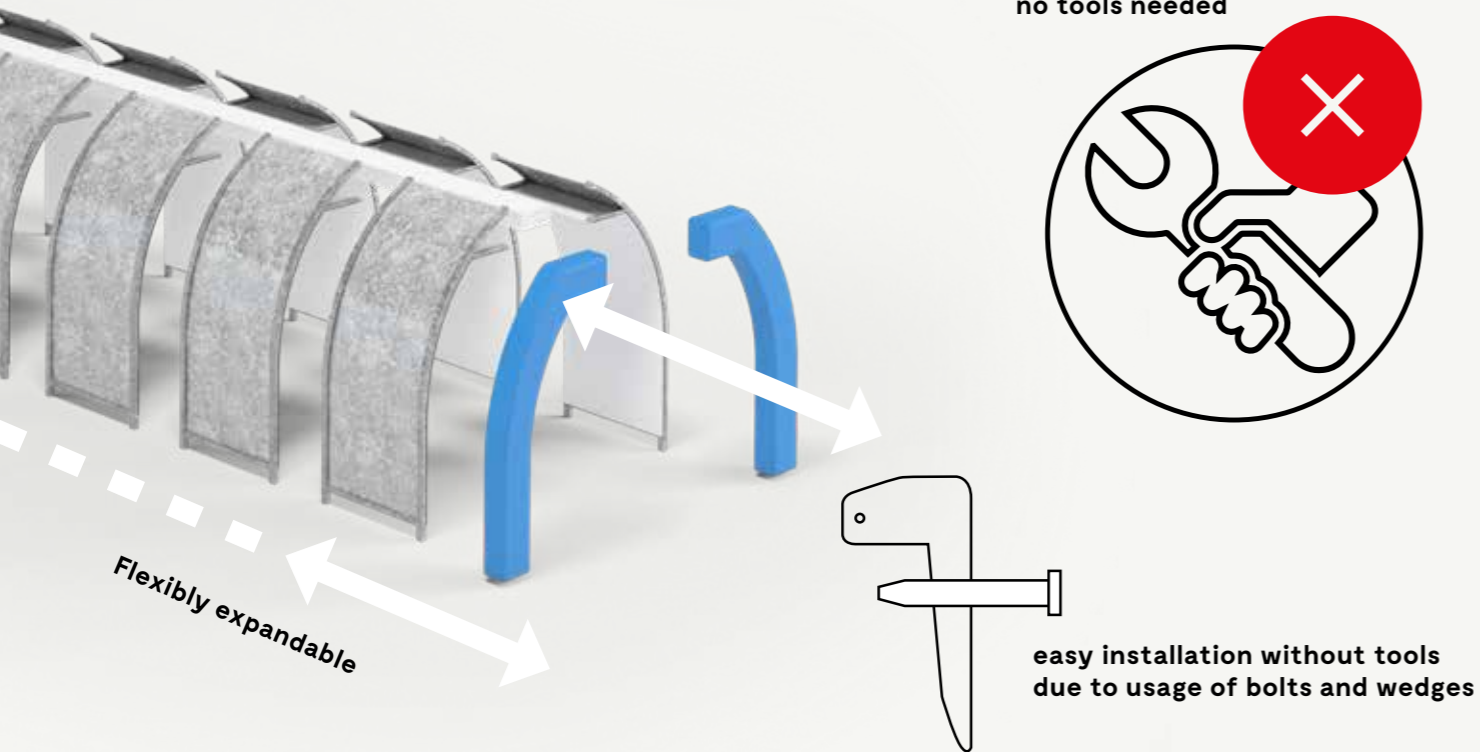

### Air cell isolation - The world's only system

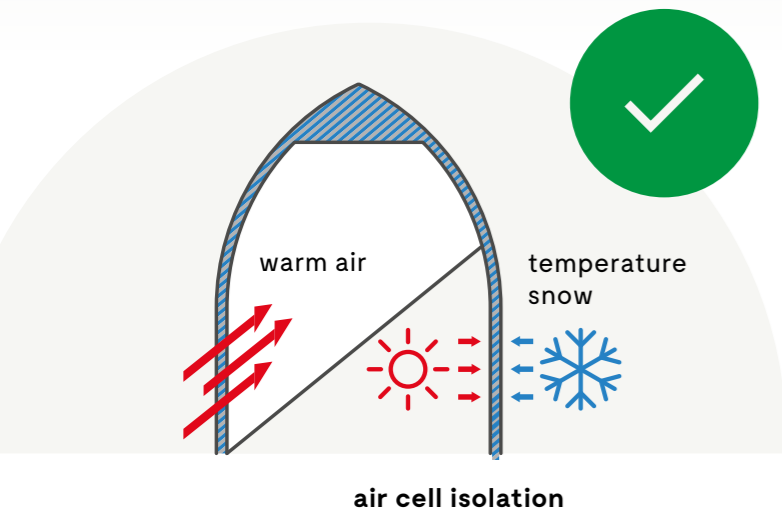

Double walled air isolation prevents the melting of holes in the snow and the collapse during the cross over with a snow groomer.

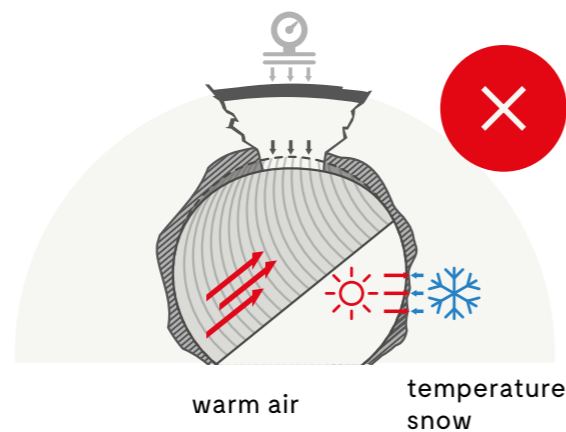

Single layer walls, corrugated iron, GRP or synthetic materials tend to cause the melting of holes in the snow. These holes can collapse during a cross over and the tunnel will be deformed or even cave in.

## Individualization

individual branding for inner zone, formwork and sounds

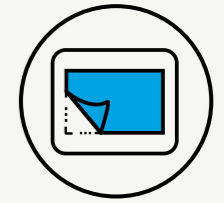

### TUNNEL - BRANDING

- all over digital print with scratch resistant protective laminate
- about 50sqm branding area in the inner zone of a 10m tunnel

### TUNNEL - BRANDING

Price on request; depends on the length of the tunnel

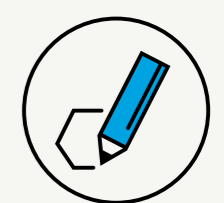

### FORMWORK

- individual design possible
- form is freely selectable within the template
- helps to create the crossing width with less snow

### TUNNEL - FORMWORK



# Light-/Sound-Effects

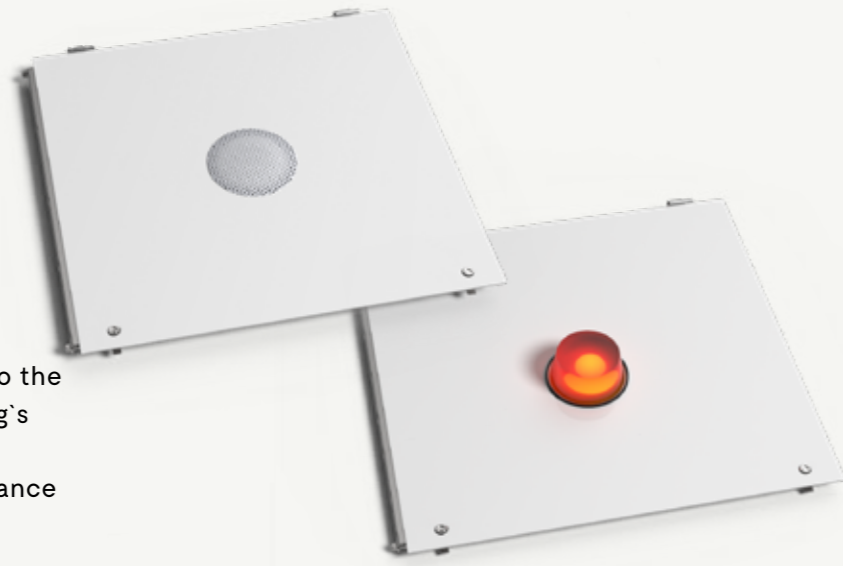

## Light

- From the rotating beacon to the LED light show - everything's possible
- light system also in accordance to customer wishes

## Sound

- MP3 Player with SD card
- Schneestern Soundpackage (about 20 sounds) + individual sounds by arrangement

- » Triggering via radar sensor inside the tunnel
- » Choice of battery or mains supply operation

## TUNNEL - LIGHT/SOUND

Price depends on length of the tunnel

# Transport



- specially developed transport system for all side and ceiling elements
- straightforward transport to desired location with the snow groomer
- space-saving storage

## TUNNEL - TRANSPORT SYSTEM

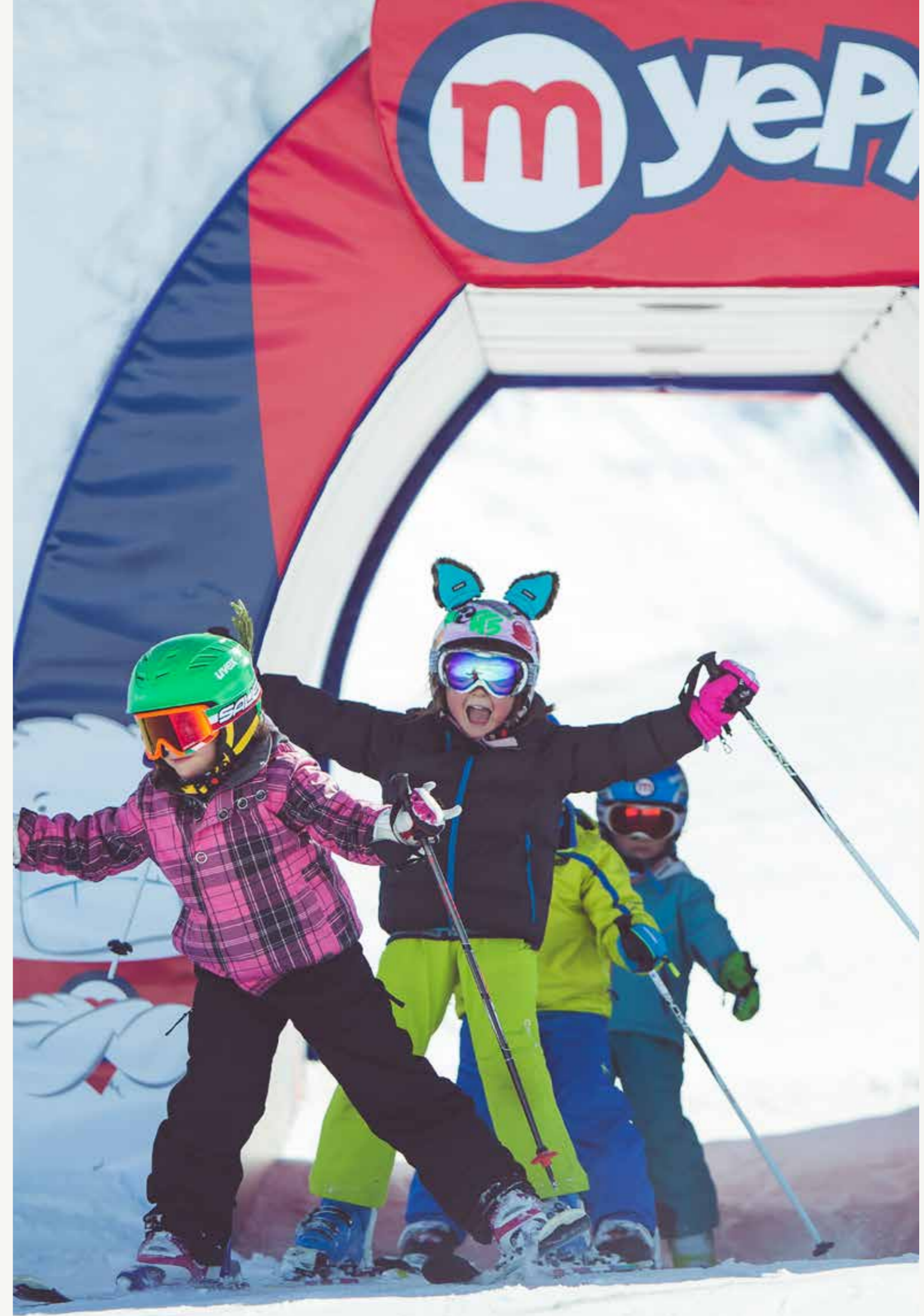



## BLOW-UP TUNNEL CURVED XL

Order-Nr. CBAGXL

Size: 10 x 3,5 x 3,5m (l x w x h)

Material: Air Bag  
 Accessory: loops for tying down and anchor, electric blower, overpressure valve, zipper for faster relief, packing bag and 4m extension hose  
 Extras: can be driven through with the PistenBully 100

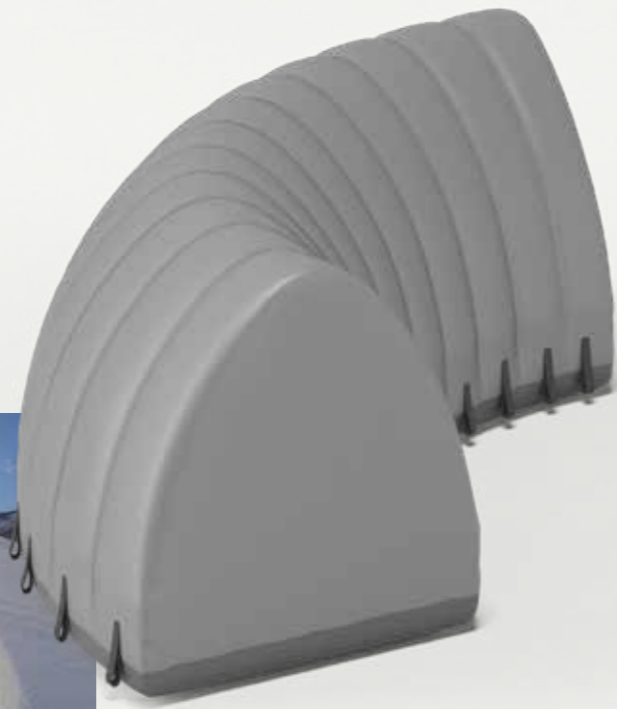

## BLOW-UP TUNNEL CURVED

Order-Nr. CBAGL



Size: 12 x 2,6 x 2,6m (l x w x h)

## BLOW-UP TUNNEL M

Order-Nr. BAGM

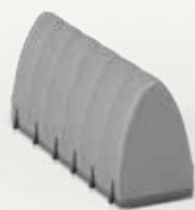

Size: 6 x 1,8 x 2,6m (l x w x h)

## BLOW-UP TUNNEL L

Order-Nr. BAGL

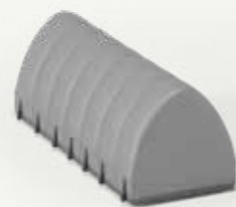

Size: 7 x 2,8 x 2,6m (l x w x h)

## BLOW-UP TUNNEL XXL

Order-Nr. BAGXL

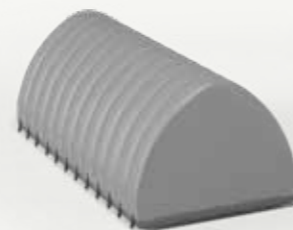

Size: 12 x 6 x 4,75m (l x w x h)

## SNOW TUNNEL IMPACT PROTECTION ARCH

Order-Nr. SNOWTARCH



Size: 3,47m x 3m (w x h)

two-parted protection pad arch for snow tunnel BAGM  
 Material: Protection pad 18cm thick, frontside printed, sides/ backside white  
 Accessory: 4 husks for robinia-sticks and anchoring set  
 Outline designable within template

## SNOW TUNNEL IMPACT PROTECTION S

Order-Nr. SNOWTPPS



Size: 2 x 0,8m (h x w)

Half-round snowtunnel pad  
 Branding: Padding covered with printed tarp  
 Accessories: incl. 2 poles for build-up

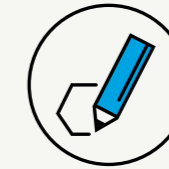

For each size of the tunnel there is the appropriate and customizable impact protection



## SNOW TUNNEL IMPACT PROTECTION L

Order-Nr. SNOWTPPL



Size: 2m high, length of the sides: 1,1m x 1,1m x 1,5m

Triangular snowtunnel pad  
 Branding: Padding covered with printed tarp  
 Accessories: incl. 2 poles for build-up



# ARCHWAY ENTRANCE



Modern entrance and exit solutions are central to visitor guidance and the highlighting of important junctions in winter sports areas. The Schneestern Archway Entrance is ideal for this. Easy handling, customizable and designed for use at all altitudes. All in all the solution to attract attention and provide orientation.

statically tested design for wind speeds up to 120 km/h

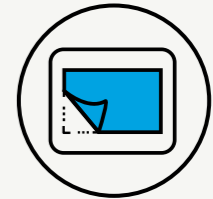

Impact protection can be individually designed

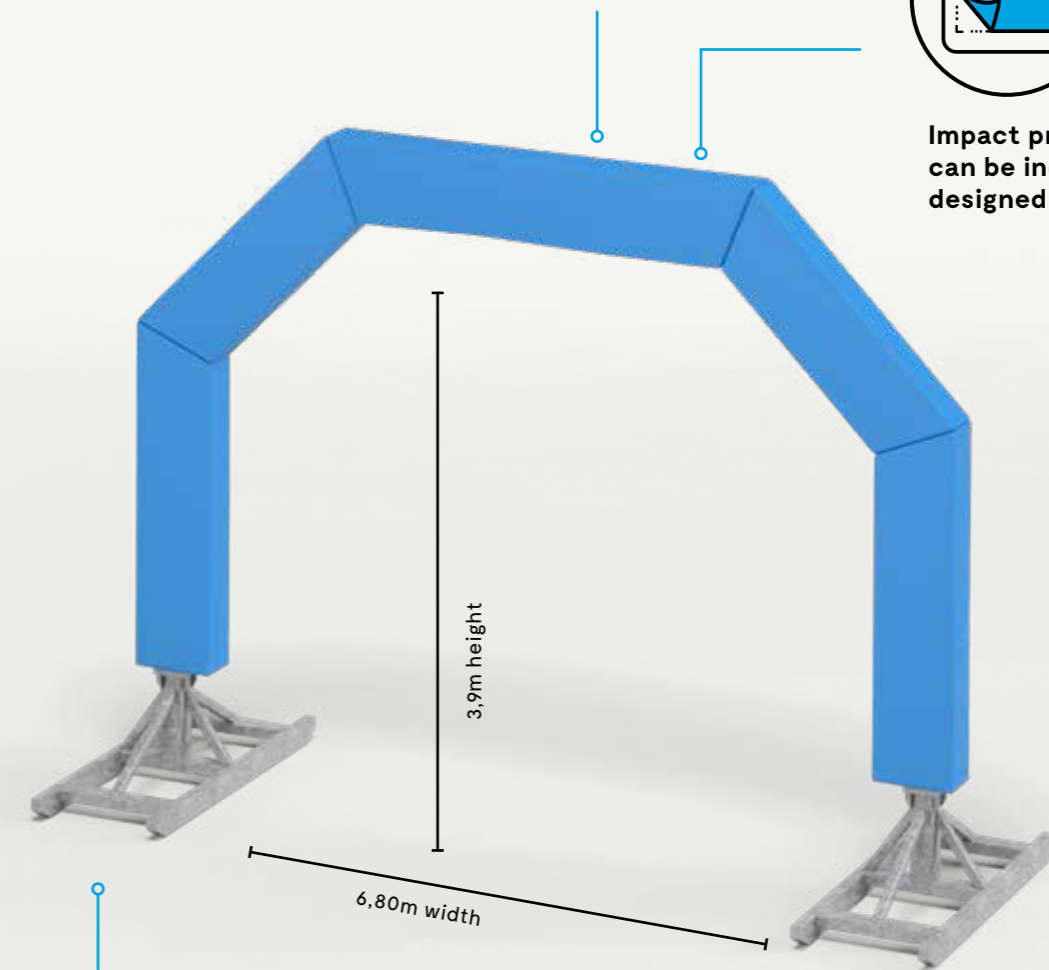

Fast and simple assembly and installation

suitable for passage with the snow groomer

Sled acts as snow anchor

## ARCHWAY ENTRANCE

Order-Nr.: ARCHWAY

Size: 8 x 5m (w x h) 12-parted

Material: aluminum/ steel construction padded with 0,06m foam  
Accessories: incl. two sleds for the anchoring in the snow  
Branding: foam covered with branded tarp



## ENTRANCE PORTAL

Order-Nr. PORTAL

Statically tested design for wind speeds up to 90 km/h

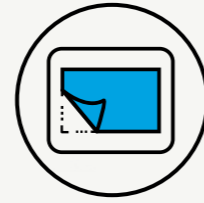

## SIGNAGE - LINK TO DOWNLOAD

www.schneestern.com

Smart Style! That's the name of the concept that's established itself worldwide as the basic system of rules for snowparks and freestyle facilities. With the motto "Freestyle — yes, Chaos — no", emphasis is laid on the personal responsibility of freestyle terrain users. We also have developed a quiet similar system for congeneric infrastructures like the Fun Line.

With Schneestern safety signs you'll show your guests how to conduct themselves properly in the snowpark & co. and leave smarter than when they dropped in. Be smart — choose Schneestern. We believe that guidelines and information tables about the safe use of an Action & fun infrastructures should be free of market competition. That's why we also offer our graphics for free download:

WWW.SCHNEESTERN.COM

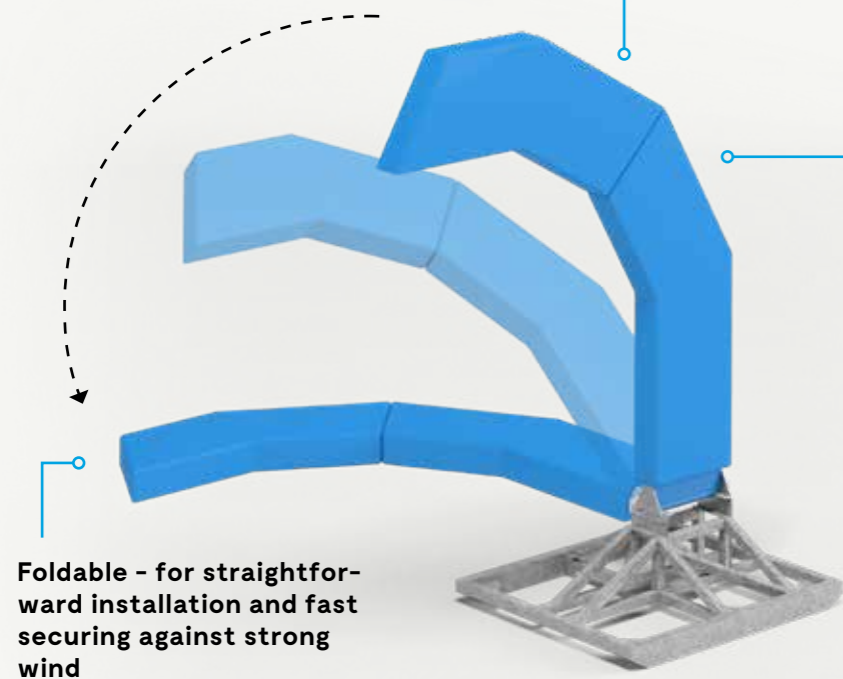

entrance solution with high recognition value and attractive design

Impact protection can be individually designed

Foldable - for straightforward installation and fast securing against strong wind

Size: visible height 4,05m, clearance height 3,4m, width 3,75m

Material: Hot zinc dipped steel construction, on both sides padded with two-parted, 0,06m thick protection pad - pad covered in tarp incl. allover digital print  
Extras: Open/ Closed integration possible with surcharge



Example for individualized Entrance Portals



## SLED FOR PORTAL

Bestell-Nr. PORTALSLED

Sled acts as snow anchor



Material: hot zinc dipped steel construction



# SNOWPARK

DE	FR	IT	EN
<p><b>erst schauen dann springen</b></p> <p><b>plane deinen Lauf</b></p> <p><b>lass es langsam angehen</b></p> <p><b>Respekt verdient Respekt</b></p> <p><b>small</b> Diese Elemente weisen eine geringe Abfahrtschneefahrt auf und sind für Anfänger geeignet.</p>	<p><b>regarde avant de sauter</b></p> <p><b>planifie ton passage</b></p> <p><b>vas-y gentiment</b></p> <p><b>le respect invite au respect</b></p> <p><b>small</b> La hauteur de chute de ces éléments est peu importante et ils peuvent être pratiqués en glissant (surtout par les novices dans les snowparks).</p>	<p><b>controlla prima di saltare</b></p> <p><b>planifica la discesa</b></p> <p><b>progredisce un passo per volta</b></p> <p><b>rispetto chiede rispetto</b></p> <p><b>small</b> Questi elementi hanno un'esigua altezza di caduta e sono utilizzabili anche dagli inesperti (snowparks).</p>	<p><b>look before you leap</b></p> <p><b>make a plan</b></p> <p><b>easy style it</b></p> <p><b>respect gets respect</b></p> <p><b>small</b> These elements have a low fall height and are reliable (even for beginners).</p>

**Start small and work your way up.**

**Start small and work your way up.**

www.schneestern.com





## ENTRANCE SIGN

Order-Nr. ENTRANCESIGN



Size: 2,2 x 0,72m (h x w)

Material: hot-zinc dipped steel frame, protection pad 0,06m thick

Branding: covered with branded tarp

Extras: snow anchor 0,3m high

## OPEN/CLOSED SYSTEM

Order-Nr. ENTRANCESIGNOC



Size: 0,40 x 0,60m (w x h)

Material: branded tarp with PE-Stripes and latches foldable to display the satate of the slope status

## ENTRANCE/EXIT TOWERS

Order-Nr. TOWER



Size: 1,5 x 2,5 (w x h)

Material: hot zinc dipped steel frame coated with 6cm protection pad, Accessory: guest counting integrable on extra charge, Branding: covered with branded tarp; incl. allover print 2,5 x 1,5m





## STARTGATES

- entrance solution with high recognition value and attractive design
- Defined starting point for joint starting in a ski area (e.g. speed check, funline etc.)
- Start handles for pulling in and fast speed increase
- Number of start gates adaptable to desired number of persons
- individual form and design possible

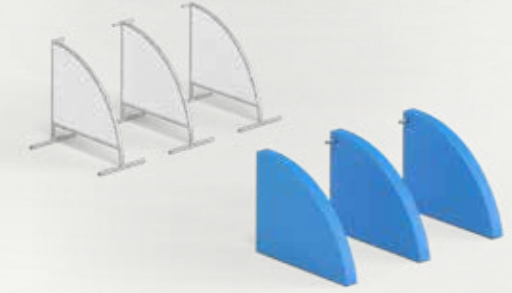

### STARTGATE M (WAVE/QUARTER)

Order-Nr. Startgate M (Wave/Quarter)

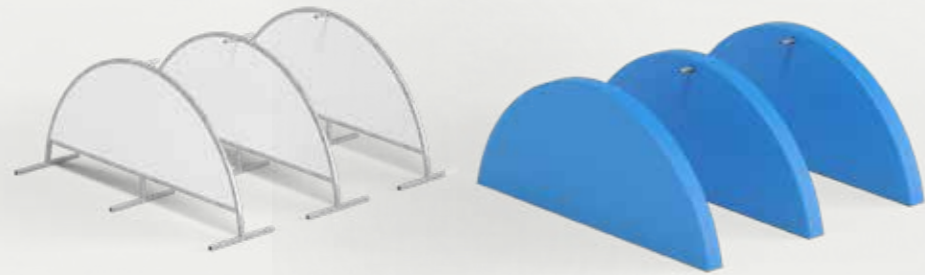

### STARTGATE L (RAINBOW)

Order-Nr. Startgate L (Rainbow)



branding example

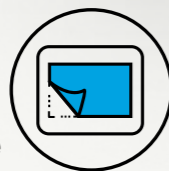

individualization example

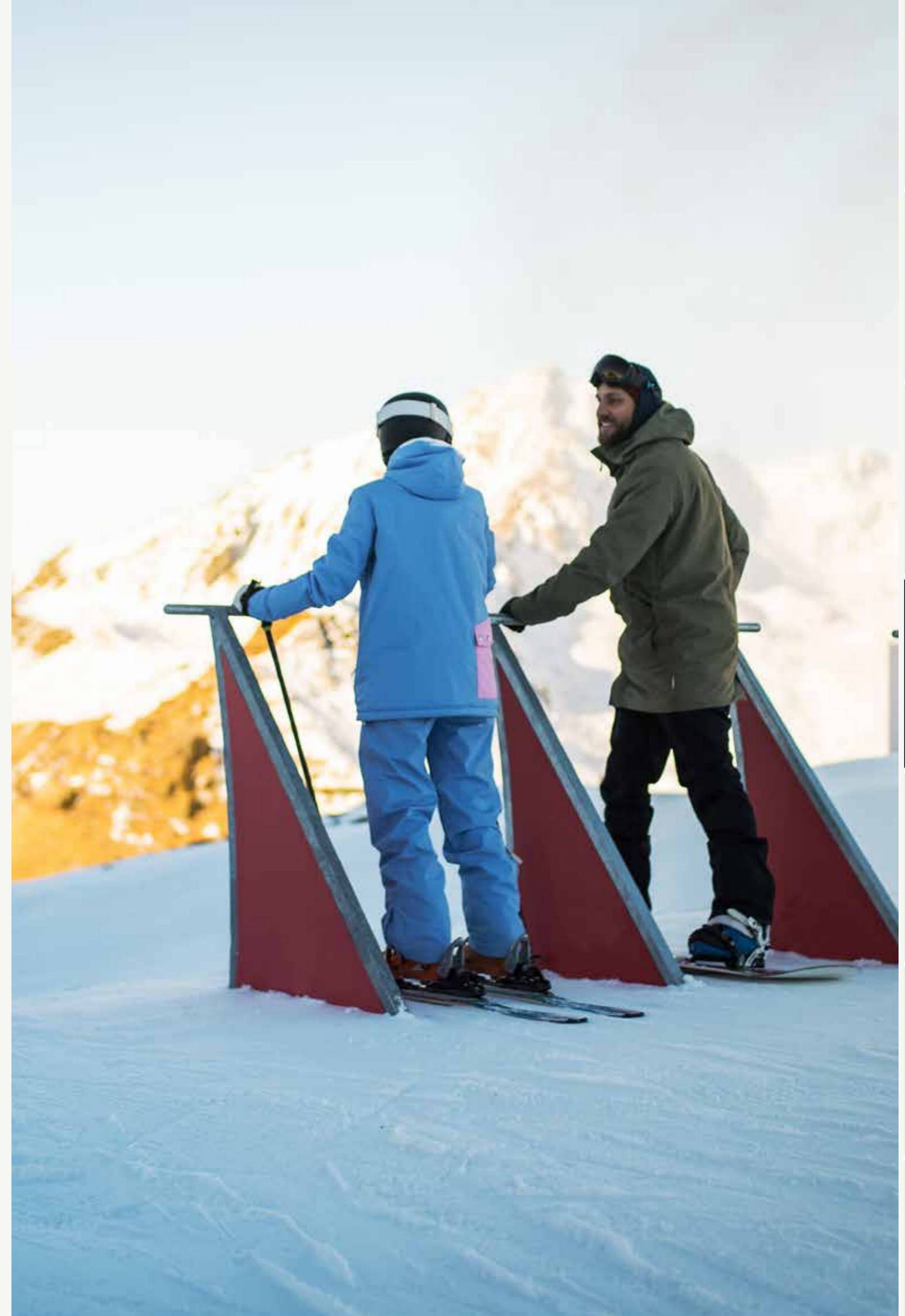





# FREESTYLE- PARK



# Application

# Freestylepark



TANK TUBE



WALLRIDE  
SPINE

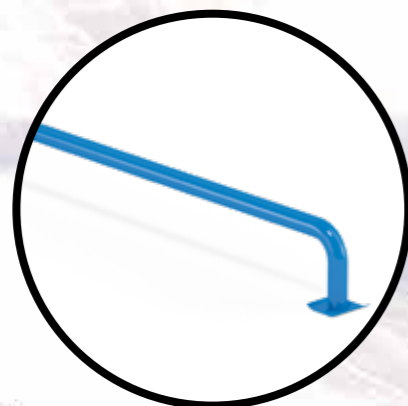

INDUSTRY FLAT



DOWN-FLAT-DOWN  
MODULAR BOX

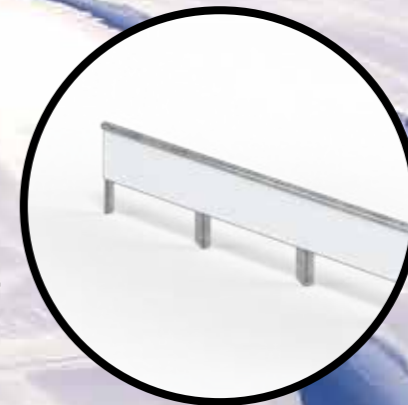

PIG PIPE FLAT

As the „oldest“ park concept among the snow-parks, the Freestylepark has developed into a variety of specific course designs. Depending on the size of the target group and the specific type of “Freestyler” you want to address the design of the Freestylepark should accordingly be adopted. Main concerns are not primarily the difficulty of the park, but rather the size and the focus on a certain freestyle discipline.

## Target groups

- Kids
- Freestyle beginners
- Freestyle intermediates
- Freeriders



# Profile

It's the mixture that matters! Don't stock your snowpark with the same old boxes and rails. Mix up your elements with various profiles and bring diversity into your park. Your clients will thank you for it. Almost all Schneestern obstacles are availa-



**BOX**



**POSTBOX**



**BUTTERBOX**



**BIG PIPE**



ble in four different profiles, so that you can offer obstacles for every level of riding. Our "Profile Buttons" will show you which obstacles are available in which profiles

# Safety profile

Often imitated, never equaled: The Schneestern Safety Profile. Since 2008 the first of its kind on the market and TÜV Süd certified, our safety profile promises maximal safety. Through the seamless integration of all construction parts and the round profile, the point loading is minimized in the case of a fall, preventing serious injuries. With our special production techniques, we can produce this profile for round and curved obstacles as well

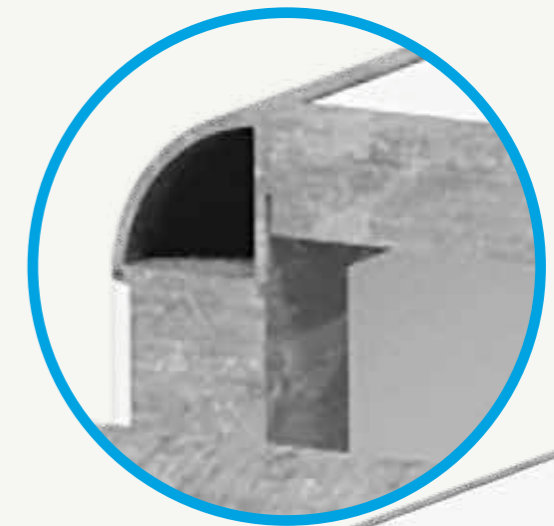

**NO JAMMING OR TILTING**

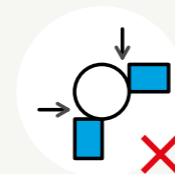
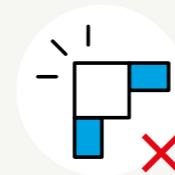



# Construction

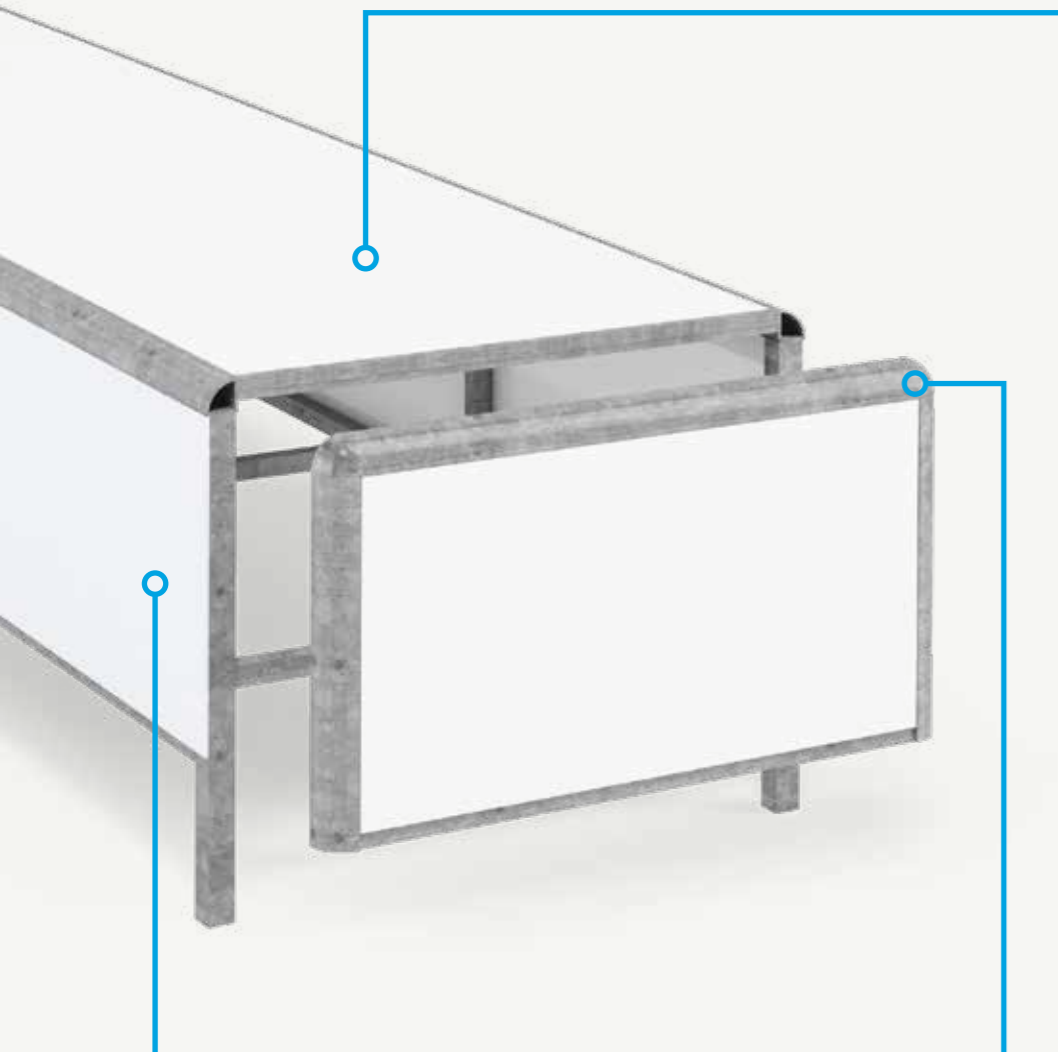

## SLIDING SURFACE

To make our sliding surfaces of thermoplastic polyethylene (PE) as durable, safe and slippery as possible, they're screwed discretely into the undersides, so that the sliding surface remains unblemished. The Schneestern frame profile compensates thermic expansion. Best riding characteristics and the highest safety standards are guaranteed.

## CONSTRUCTION

What makes a good snowpark obstacle? We believe that a good obstacle must unite the right mix of stability, durability and safety with easy handling for shapers and enjoyment for riders. To achieve this, we're continually developing the steel-frame construction that's the basic frame of our obstacles. For optimal corrosion protection, all metal elements are hot zinc dipped or powder-coated.

## SKIRTING

The side panelling of all Schneestern rails and boxes is made of unbreakable, splinter-free aluminum dibond sheets. In combination with the Schneestern Safety Profile, we guarantee a maximum of safety. For easy handling and installation, we add two installation flaps on each side.

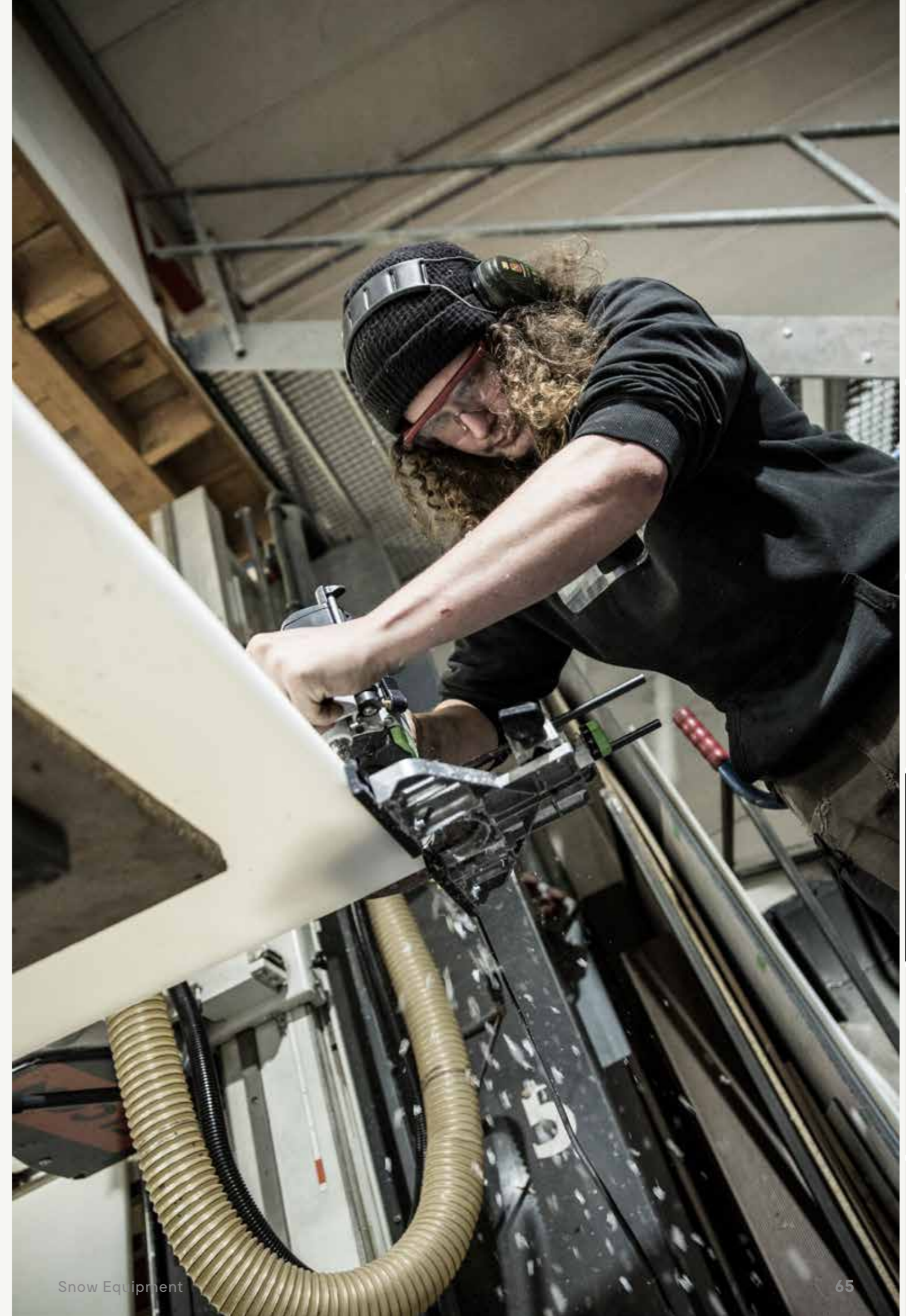



## KIDS FLAT 4M

Order-Nr. KBFL4



Size: 4 x 0,5 x 0,4m (l x w x h)



Profile: One piece kids box  
 Material: hot zinc dipped steel frame  
 Side panelling: 4mm Dibond- white, riveted  
 Slide-surface: 20mm PE- blue- screwed from below



## KICKERBANK

Order-Nr. KICKERBANK

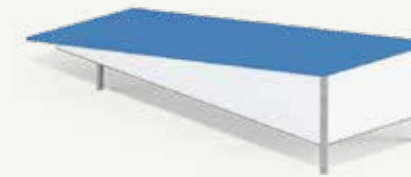

Size: 3 x 1 x 0,5m (l x w x h)



Profile: One piece butter box  
 Material: hot zinc dipped steel frame  
 Side panelling: 4mm Dibond - white - riveted  
 Slide-surface: 20mm PE - blue - screwed from below  
 Extras: multi functional butter obstacle, can be used as bank, kicker, butterbox, wallride

## FUNLINE FLATBOX PT

Order-Nr. KBFL5XLPT

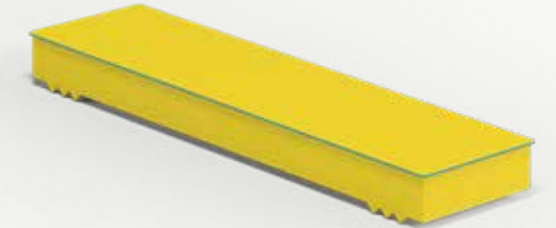

Size: 5 x 1,3 x 0,4m (l x w x h)



Material: hot zinc dipped steel frame  
 Side panelling: 4mm Dibond incl. laminated digital print  
 Slide surface: 19mm Playtec e.g. blue - yellow - blue  
 Profile: One piece butter box

## KIDS RAINBOW 4M

Order-Nr. KBRA4



Size: 4 x 0,5 x 0,4m (l x w x h)



Profile: One piece kids box (Icon) Material: hot zinc dipped steel frame  
 Side panelling: 4mm Dibond- white, riveted Slide-surface: 20mm PE- blue- screwed from below

## KIDS UP&DOWN 4M

Order-Nr. KBUD4



Size: 4 x 0,5 x 0,4m (l x w x h)



Profile: One piece kids box (Icon) Material: hot zinc dipped steel frame  
 Side panelling: 4mm Dibond- white, riveted Slide-surface: 20mm PE- blue- screwed from below

## FUNLINE RAINBOW PT

Order-Nr. KBRA5XLPT



Size: 5 x 1,3 x 0,4m (l x w x h)



Material: hot zinc dipped steel frame  
 Side panelling: 4mm Dibond incl. laminated digital print  
 Slide surface: 19mm Playtec e.g. blue - yellow - blue  
 Profile: One piece butter box

## FUNLINE UP&DOWN PT

Order-Nr. KBUD5XLPT

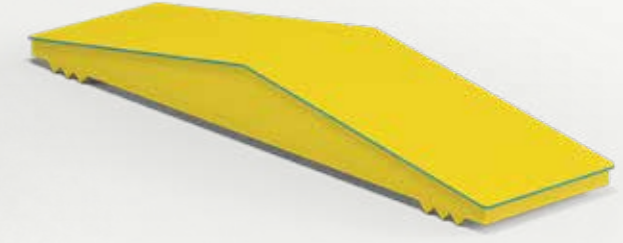

Size: 5 x 1,3 x 0,4m (l x w x h)



Material: hot zinc dipped steel frame  
 Side panelling: 4mm Dibond incl. laminated digital print  
 Slide surface: 19mm Playtec e.g. blue - yellow - blue  
 Profile: One piece butter box

For detailed information on PT-Surfaces see page 22







### BUTTERBOX 6M

Order-Nr. OP.FL606

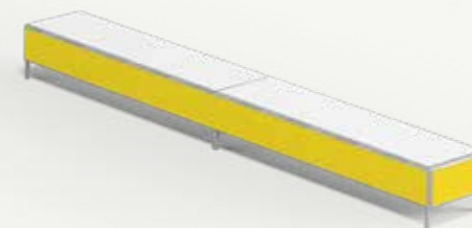

Size: 6 x 0,4m (l x h)



Profile: One Piece Butter Box  
 Material: hot zinc dipped steel frame  
 Side panelling: 4mm Dibond- varnished in color- riveted  
 Slide surface: 20mm PE- white- screwed from below

### KINKED BUTTERBOX 7M

Order-Nr. KI606

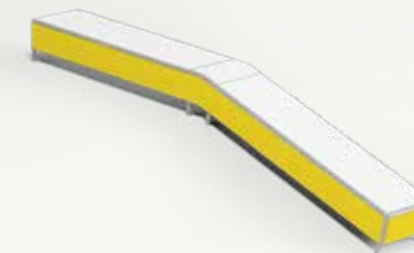

Size: 7 x 0,4m (l x h)



Modular-system:  
 2 x Flat element 3m long/ 0,4m high  
 1 x Kinked connector 16°/ 0,4m high  
 2 x End panel 0,4m high  
 Side panelling: 4mm Dibond- varnished in color- riveted

### WAVE BUTTER BOX 6M

Order-Nr. WA606

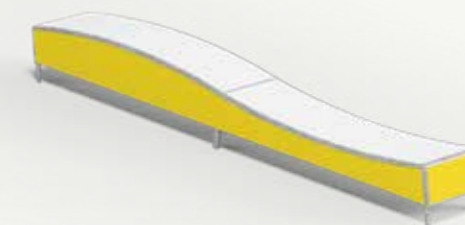

Size: 6 x 0,4m (l x h)



Modular-system:  
 1 x mRA306- Rainbow- element 3m long/ 0,4m high  
 1 x mBA306- Banana- element 3m long/ 0,4m high  
 2 x mAD06- End panel 0,4m high  
 Side panelling: 4mm Dibond- varnished in color- riveted





# Kids Slopestyle Package

## What is a Kids Slopestyle?

The idea for the Kids Slopestyle was born during the planning of the slopestyle course for the Olympic Winter Games. Why not build an equivalent set-up for the Olympic stars of tomorrow?

And so the concept of the Kids Slopestyle was born - It's all about fun and kids, together with their parents they can taste some fresh "freestyle air". A snowpark, inspired from the Olympics,

but built for kids and families and is also perfect for freestyle beginners.

- All jumps & obstacles at kids-level
- Ideal training environment for kids and freestyle beginners
- Top-to-bottom on a wide variety of Freestyle obstacles
- Inspired by the design of the Olympic courses



TRIBUNE

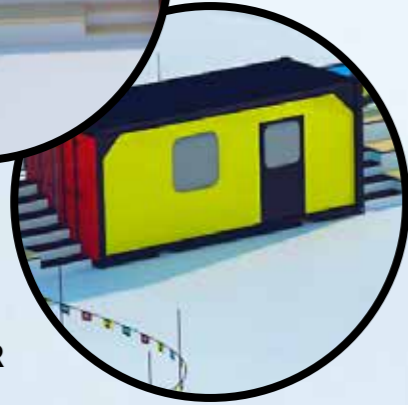

CONTAINER

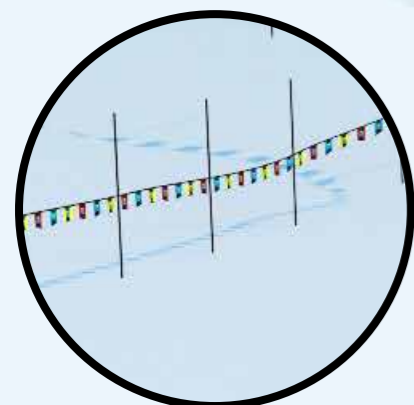

BARRIER LINE



**KIDS FLAT 4M**  
Bestell-Nr. KBFL4



**FUNTUBE**  
Bestell-Nr. FT 1/1 0,5-5

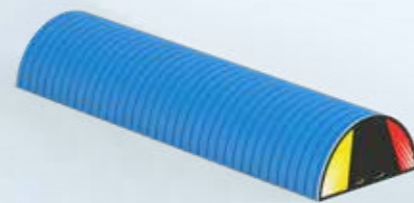

**1/2 FUNTUBE**  
Bestell-Nr. FT 1/2 1,5-5



**POSTBOX 4M**  
Bestell-Nr. FL407L



**KIDS RAINBOW 4M**  
Bestell-Nr. KBRA4



**KIDS UP&DOWN 4M**  
Bestell-Nr. KBUD4



**ENTRANCE ARCHWAY**  
Bestell-Nr. ARCHWAY



## POSTBOX FLAT 6M

Order-Nr. FL607L



Size: 6,5 x 0,5m (l x h)



Profile: One piece post box  
Material: powder coated steel frame- black  
Side panelling: 4mm Dibond- white- riveted

## POSTBOX FLAT 10M WITH POLE JAM

Order-Nr. FL1007L



Size: 10 x 0,5m (l x h)



Profile: Two piece post box  
Material: powder coated steel frame- black  
Side panelling: 4mm Dibond- white- riveted

## POST BOX KINKED 10M

Order-Nr. KI1007L



Size: 10 x 0,5m (l x h)



Profile: Two piece post box  
Material: powder coated steel frame- black  
Side panelling: 4mm Dibond- white- riveted

## POSTBOX TRANNY FINDER 8M

Order-Nr. TF807L



Size: 8 x 0,5m (l x h)



Profile: Two piece post box  
Material: powder coated steel frame- black  
Side panelling: 4mm Dibond- white- riveted

## POSTBOX DOWN FLAT DOWN 12M

Order-Nr. DFD1207L



Size: 12 x 0,5 - 0,75m (l x h)



Profile: Three piece post box  
Material: powder coated steel frame- black  
Side panelling: 4mm Dibond- white- riveted





## INDUSTRY FLAT

Order-Nr. INDYFLAT



Size: 6,8 x 0,9m (l x h), 0,22m ø



Material: varnished steel- all Standard RAL colors feasible without surcharge



## INDUSTRY UP&DOWN

Order-Nr. INDYUPDOWN

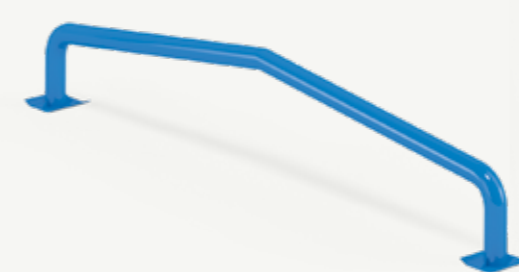

Size: 6,8 x 0,9m (l x h), 0,22m ø



Material: varnished steel- all Standard RAL colors feasible without surcharge

## INDUSTRY ELBOW

Order-Nr. INDYELBOW



Size: 6,8 x 0,9m (l x h), 0,22m ø



Material: varnished steel- all Standard RAL colors feasible without surcharge

## INDUSTRY FLAT HIGH

Order-Nr. INDYHIGH



Size: 6,8 x 1,4m (l x h), 0,22m ø



Material: varnished steel- all Standard RAL colors feasible without surcharge

## INDUSTRY CANNON

Order-Nr. INDYCANNON



Size: 6,4 x 0,9m (l x h), 0,22m ø



Material: varnished steel- all Standard RAL colors feasible without surcharge

## INDUSTRY S-RAIL

Order-Nr. INDYS



Size: 7,8 x 0,9m (l x h), 0,22m ø



Material: varnished steel- all Standard RAL colors feasible without surcharge





## INDUSTRY RAINBOW

Order-Nr. INDYRAINBOW



Size: 6,3 x 0,5-1,3m (l x h), 0,22m ø



Material: varnished steel - all Standard RAL colors feasible without surcharge

## INDUSTRY RAINBOW HIGH

Order-Nr. INDYRAINBOWBRAND



Size: 6,3 x 0,9-1,5m (l x h), 0,22m ø



Material: varnished steel - all standard RAL colors feasible for the industry rail without surcharge

## INDUSTRY FLAT DOWN

Order-Nr. INDYKINKED



Size: 8,8 x 0,9m (l x h), 0,22m ø



Material: varnished steel- all Standard RAL colors feasible without surcharge

## INDUSTRY DOWN FLAT

Order-Nr. INDYDONKEY



Size: 7,8 x 0,9m (l x h), 0,22m ø



Material: varnished steel- all Standard RAL colors feasible without surcharge

## INDUSTRY TRANNY FINDER

Order-Nr. INDYCURVED



Size: 8 x 0,9m (l x h), 0,22m ø



Material: varnished steel- all Standard RAL colors feasible without surcharge

## INDUSTRY CURVED

Order-Nr. INDYCURVED



Size: 6,3 x 0,9m (l x h), 0,22m ø



Material: varnished steel- all Standard RAL colors feasible without surcharge



## INDUSTRY WATERFALL

Order-Nr. INDYWATERFALL



Size: 10 x 1,1 (l x h), 0,22m ø



Material: varnished steel- all standard RAL colors feasible for the industry rail without surcharge  
Side panelling: Dibond 4mm- riveted- plastered with laminated digital print



## FUNTUBE 0,5MØ

Bestell-Nr. FT 1/1 0,5-5



Size: 5m long, 0,5m ø



Material: PE  
Standard colour: light-blue  
Extras: Incl. white end panels, black stilts and white snow anchors

## HOVERTUBE

Order-Nr. HT6

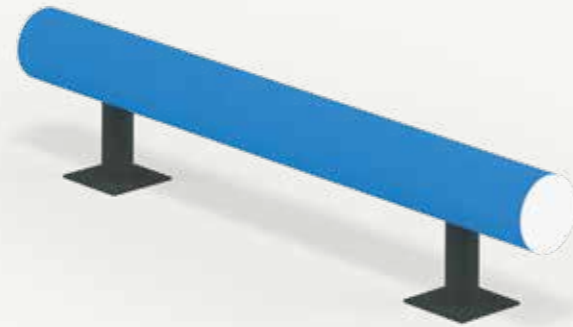

Size: 5m long, high 1,25, 0,5m ø



Material: PE  
Standard colour: light-blue  
Extras: Incl. white end panels, black stilts and white snow anchors

## 1/2 FUNTUBE 1,5MØ

Bestell-Nr. FT 1/2 1,5-5



Size: 5m long, 1,5m ø



Material: half PE tube  
Standard colour: light-blue  
Extras: Incl. end panels, side-anchors and carrying handles

## TANK TUBE

Bestell-Nr. FT 1/1 1,8-4

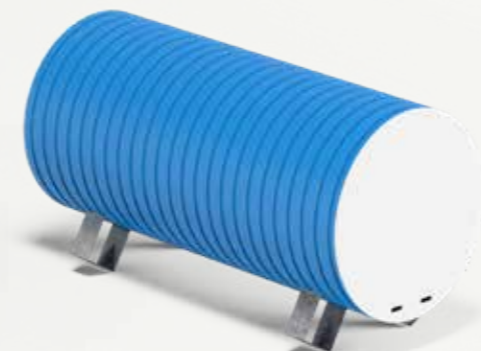

Size: 4m long, 1,8m ø



Material: PE  
Standard colour: light-blue  
Extras: Incl. end panels, side-anchors and carrying handles





# One Piece

**Endless Possibilities.** Agility, easy handling and tool-free installation make snow-park shapers happy; simplicity and endless trick possibilities excite riders. “Ready to shred”—just put our one-piece elements in place, and they’re ready to go!

**Dimensions:** Standard length: 6 m

## ⊕ ADVANTAGES

- All rail and box profiles available
- Easy handling
- No installation
- Diminished costs of purchase
- Easy maintenance



**BOX**

Size: 6 x 0,5m (l x h)  
 Profile: One piece box  
 Material: hot zinc dipped steel frame  
 Side panelling: 4mm Dibond- white- riveted  
 Slide surface: 20mm PE- white - screwed from below



**BUTTERBOX**

Size: 6 x 0,4m (l x h)  
 Profile: One Piece Butter Box  
 Material: hot zinc dipped steel frame  
 Side panelling: 4mm Dibond- white- riveted  
 Slide surface: 20mm PE- white- screwed from below



**BIG PIPE**

Size: 6 x 0,5m (l x h)  
 Profile: One piece big pipe rail  
 Material: powder coated steel frame- black  
 Side panelling: 4mm Dibond- white- riveted



# Modular

**The original!** As the first and only system of its kind, the Schneestern Modular System works between all rail and box profiles. All modules can be combined with each other. The only boundary this system knows is your imagination!

**Dimensions:** Standard skirting height: 0,5 m  
 Other heights available: 0,75 m & 1,5 m

## ⊕ ADVANTAGES

- Individual snowpark design
- All modules combinable
- Absolute creative freedom
- Easy handling
- Flexibly expandable
- Easy replacement of damaged elements





# One Piece

## CROSS-SECTIONS (Available with the shapes listed below)



Box  
Order.-Nr.: 605L  
replacement for XXX



Butterbox  
Order.-Nr.: 606  
replacement for XXX



Big Pipe  
Order.-Nr.: 603L  
replacement for XXX

### RAINBOW

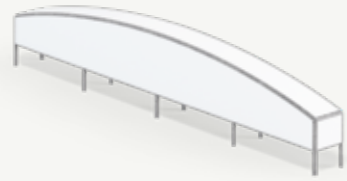

6m Order.-Nr.: OP-RAXXX

### FLAT

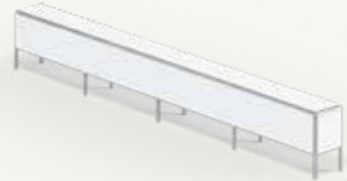

6m Order.-Nr.: OP-FLXXX  
8m Order.-Nr.: OP-FLXXX

### WAVE

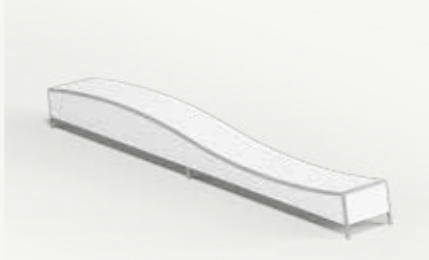

6m Order.-Nr.: OP-WAXXX

### UP & DOWN

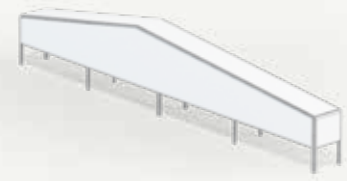

6m Order.-Nr.: OP-UDXXX

### ELEPHANT



6m Order.-Nr.: OP-ELXXX

### DOWN FLAT

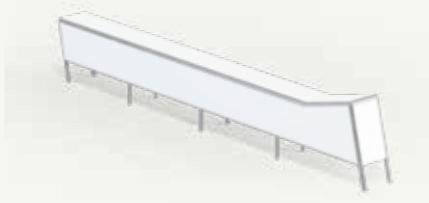

6m Order.-Nr.: OP-DFXXX

### CURVED



6m Order.-Nr.: OP-CXXX

# Modular

## FORMS (Available with the objects below)



Box Order.-Nr.:  
replace XX with 05



Butterbox Order.-Nr.:  
replace XX with 06



Rail Order.-Nr.:  
replace XX with 03

### FLAT



1m Order.-Nr.: mFL1XXL  
3m Order.-Nr.: mFL3XXL  
4m Order.-Nr.: mFL4XXL

### RAINBOW



3m Order.-Nr.: mRA3XXL  
4m Order.-Nr.: mRA4XXL

### BANANA

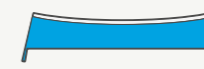

3m Order.-Nr.: mBA3XXL  
4m Order.-Nr.: mBA4XXL

### SOFTBOX



3m Order.-Nr.: mS03XXL

### CURVED



4m Order.-Nr.: mC403L

### UP ELEMENT

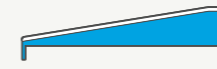

3m Order.-Nr.: mUD3XXL

### KINKED CONNECTOR



Order.-Nr.: mVK16XXL

### REVERSIBLE CONNECTOR



Order.-Nr.: mVKW16XXL

### DOUBLE KINKED CONNECTOR

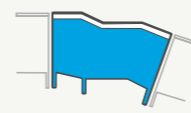

2m Order.-Nr.: mVDK16XXL

### ELBOW CONNECTOR

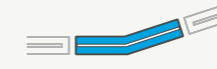

Order.-Nr.: mVEXXL

### CLOSE OUT CONNECTOR



Order.-Nr.: mVE90XXL

### POLE JAM COVER



Order.-Nr.: mADPJXXL

### STEP CONNECTOR

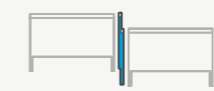

Order.-Nr.: mVSXXL

### COVER



Order.-Nr.: mADXXL



# One Piece



# Modular

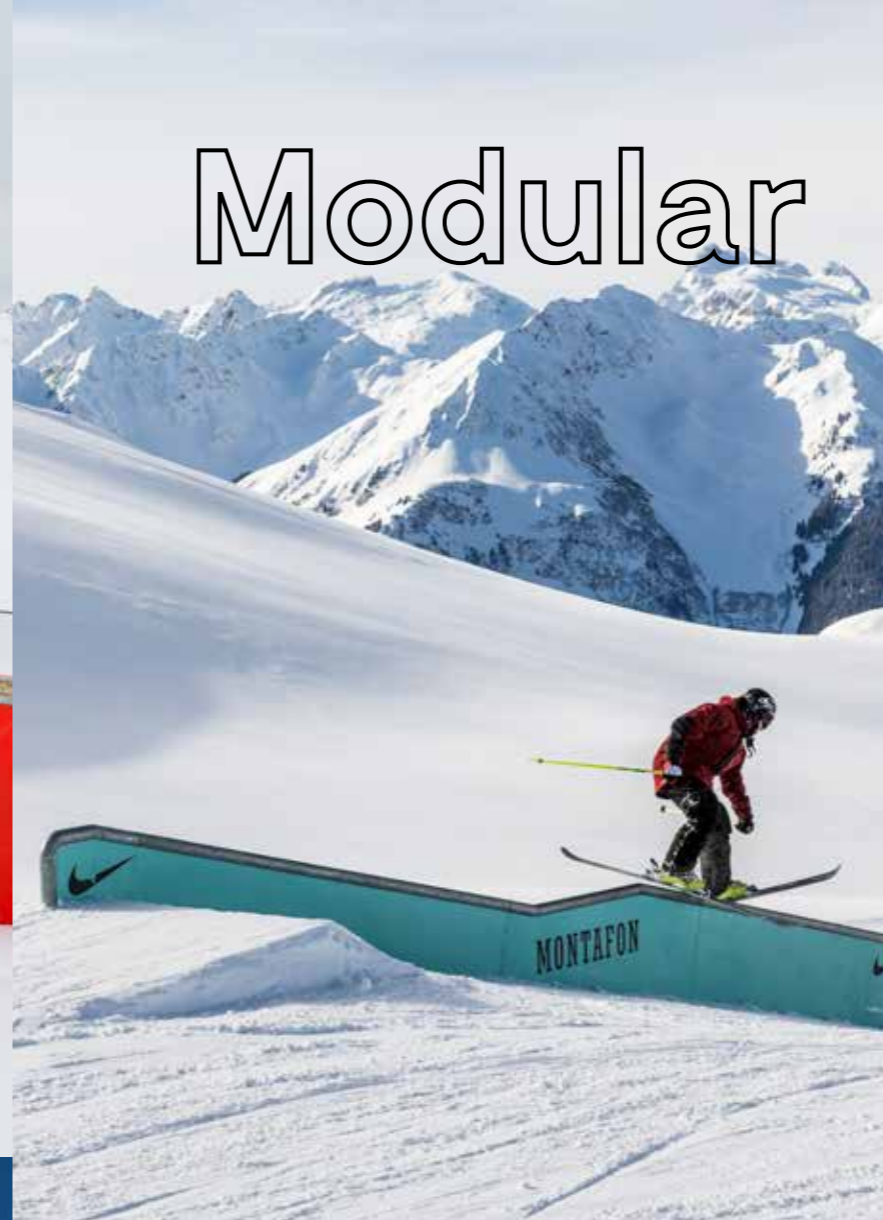

Obstacles for Skischools

Funline

Attraction

Freestylepark

Add Ons



## WALLRIDE 6M

Order-Nr. WR6



Size: 6 x 2m (l x h), two-parted Wallride



Material: hot zinc dipped steel frame  
Side panelling: 4mm Dibond- white, 1,5mm sheet metal- riveted, Slide surface: 15mm PE- white- screwed from below

## WALLRIDE 6M XL

Order-Nr. WR6XL

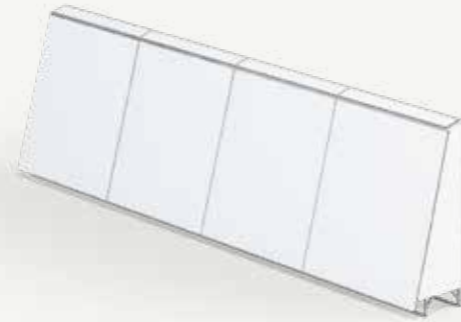

Size: 6 x 3m (l x h), four parted



Material: hot zinc dipped steel frame  
Side panelling: 4mm Dibond- white, 1,5mm sheet metal- riveted, Slide surface: 15mm PE- white- screwed from below

## WALLRIDE SPINE 3M PE

Order-Nr. WS3



Size: 3 x 2,4 x 1,1m (l x w x h), one parted



Material: hot zinc dipped steel frame  
Side panelling: 4mm Dibond- white- riveted  
Slide-surface: 15mm PE- white- screwed from below  
Accessory: incl. skids for easier handling in the snow, incl. 4m Industry rail coping

## WALLRIDE SPINE 6M PE

Order-Nr. WS6

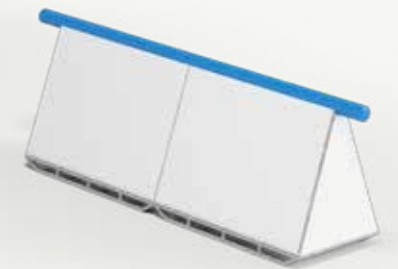

Size: 6x 2,4 x 1,1m (l x w x h), two parted



Material: hot zinc dipped steel frame  
Side panelling: 4mm Dibond- white- riveted  
Slide-surface: 15mm PE- white- screwed from below  
Accessory: incl. skids for easier handling in the snow, incl. 7m Industry rail coping



## WALLRIDE SPINE 3M BRANDED

Order-Nr. WS3SKG



Size: 3 x 2 x 1,2m (l x w x h), one parted



Material: hot zinc dipped steel frame  
Side panelling: 4mm Dibond- white- riveted  
Slide-surface: SKG- branded- glued to substructure  
Accessory: incl. skids for easier handling in the snow, incl. 4m Industry rail coping

## WALLRIDE SPINE 6M BRANDED

Order-Nr. WS6SKG



Size: 6 x 2 x 1,2m (l x w x h), one parted



Material: hot zinc dipped steel frame  
Side panelling: 4mm Dibond- white- riveted  
Slide-surface: SKG- branded- glued to substructure  
Accessory: incl. skids for easier handling in the snow, incl. 7m Industry rail coping



## SLOPE WALLRIDE

Order-Nr. SWR6

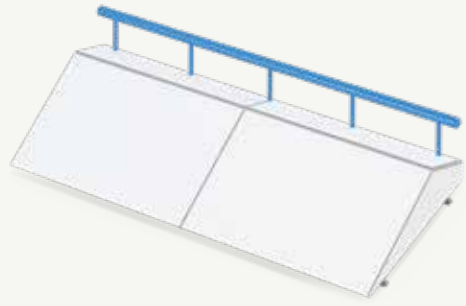

Size: 6 x 2 m (l x h), three parted



Material: hot zinc dipped steel frame  
Side panelling: 4mm Dibond- white- riveted  
Slide surface: 15mm PE- white - screwed from below  
Accessories: incl. skids for easier handling in the snow,  
incl. 6 m Coping Rail

## CURVED WALLRIDE

Order-Nr. WRC6

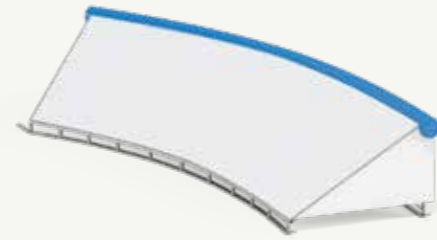

Size: 6 x 2,4 x 1,5m (l x w x h), two parted



Material: hot zinc dipped steel frame  
Side panelling: 4mm Dibond white, riveted  
Slide surface: 15mm PE- blue - screwed from below  
Accessory: Curved Industry Coping-Rail

## BATTLESHIP

Order-Nr. BATTLESHIP



Size: 9 x 3,4 x 1,5 (l x w x h), five-parted



Material: hot zinc dipped steel construction  
Slide surface: 15mm PE- white- screwed from below, front  
panelled with 4mm Dibond- white

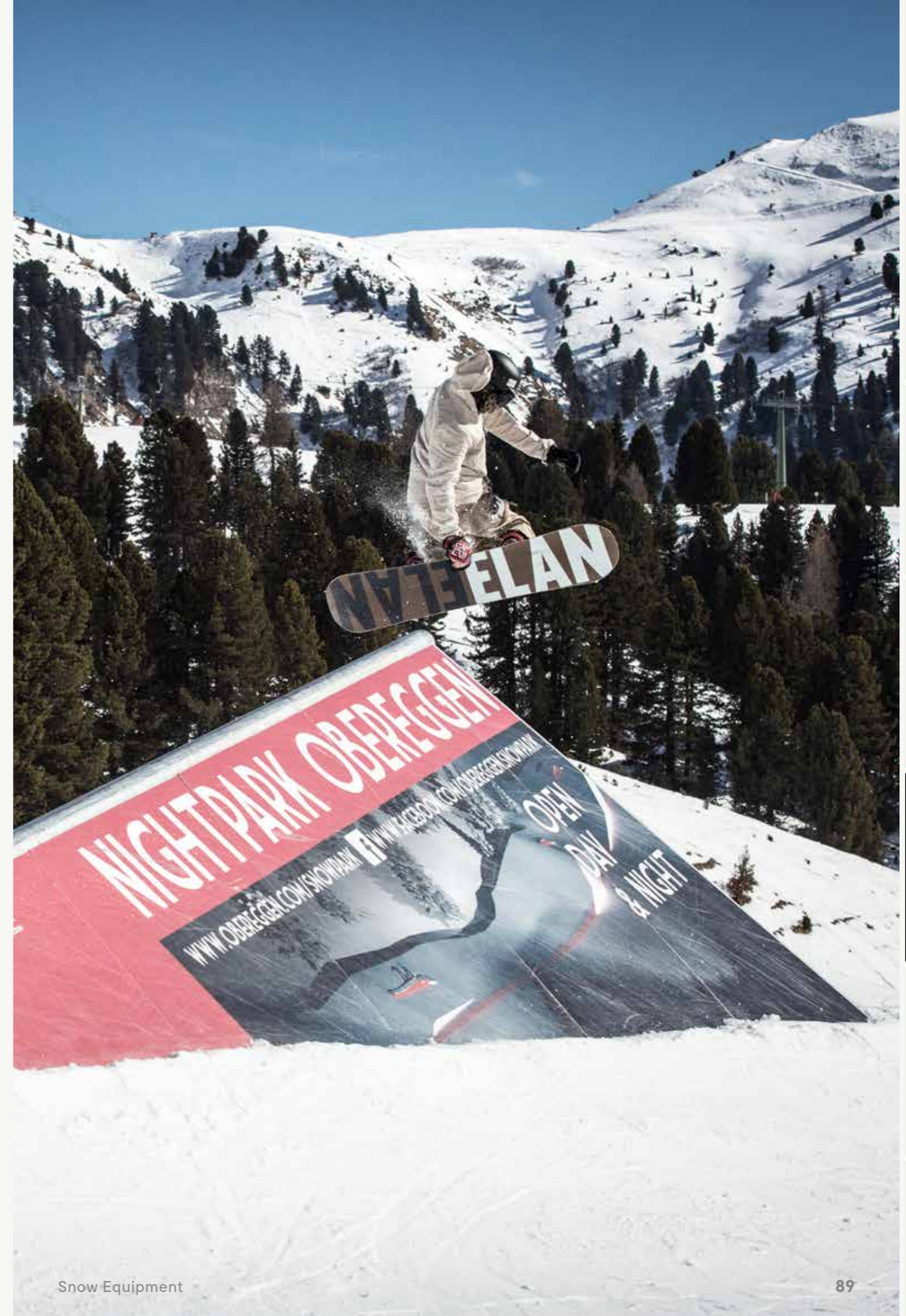



## COUCHBOX 4M

Order-Nr. BFR4

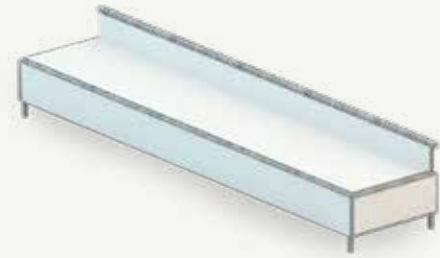

Size: 4 x 0,75 x 0,55m (l x w x h)



Profile: One piece butter box and big pipe  
Material: hot zinc dipped steel frame  
Side panelling: 4mm Dibond- white- blind  
Slide-surface: 20mm PE- white- screwed from below

## COUCHBOX WITH BANK 6M

Order-Nr. BFR6

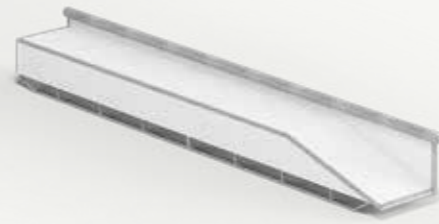

Size: 4 x 0,75 x 0,55m (l x w x h)



Profile: One piece butter box and big pipe  
Material: hot zinc dipped steel frame  
Side panelling: 4mm Dibond- white- blind  
Slide-surface: 20mm PE- white- screwed from below

## DANCEFLOOR 3M

Order-Nr. DANCEFLOOR3

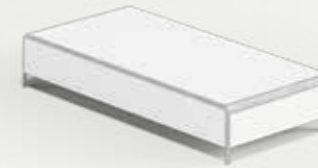

Size: 3 x 1,5 x 0,4m (l x w x h)



Profile: One piece butter box and big pipe  
Material: hot zinc dipped steel frame  
Side panelling: 4mm Dibond- white- blind  
Slide-surface: 20mm PE- white- screwed from below

## DANCEFLOOR 6M

Order-Nr. DANCEFLOOR6



Size: 6 x 1,5 x 0,4m (l x w x h)



Profile: One piece butter box and big pipe  
Material: hot zinc dipped steel frame  
Side panelling: 4mm Dibond- white- blind  
Slide-surface: 20mm PE- white- screwed from below

## BUTTERBOX WITH RAIL ELEFANT

Order-Nr. BEFR8



Size: 8 x 0,75 x 0,55m (l x w x h)



Profile: One piece butter box and big pipe  
Material: hot zinc dipped steel frame  
Side panelling: 4mm Dibond- white- blind  
Slide-surface: 20mm PE- white- screwed from below

## BUTTERBOX WITH RAIL KINKED

Order-Nr. BKIR8

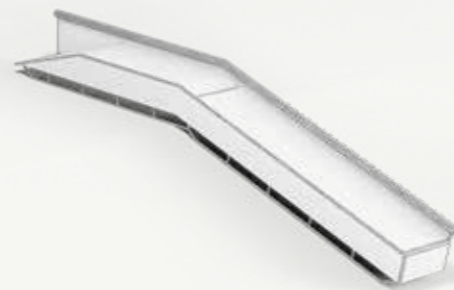

Size: 8 x 0,75 x 0,55m (l x w x h)



Profile: One piece butter box and big pipe  
Material: hot zinc dipped steel frame  
Side panelling: 4mm Dibond- white- blind  
Slide-surface: 20mm PE- white- screwed from below

## MULTIBOX

Order-Nr. MULTIBOX5



Size: 5 x 0,5m (l x h)



Profile: Flat box, slanted butter box, industry flat rail  
Material: hot zinc dipped steel frame  
Side panelling: 4mm Dibond- white  
Slide-surface: 20mm PE- white- screwed from below

## SLOPEBOX

Order-Nr. SLOPEBOX6

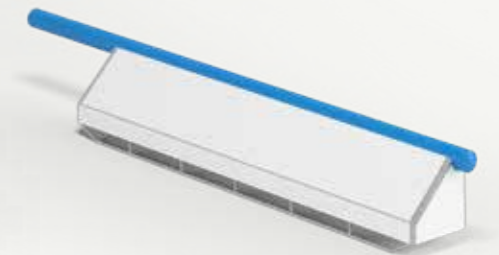

Size: 5 x 0,5m (l x h)



Profile: Slanted butter box, industry flat rail  
Material: hot zinc dipped steel frame  
Side panelling: 4mm Dibond- white  
Slide-surface: 20mm PE- white- screwed from below



## JERSEY BARRIER

Order-Nr. JERSEY3



Size: 3 x 1,1 x 1,1m (l x w x h)



Profile: One piece Box 0,2m wide  
Material: hot zinc dipped steel frame  
Side panelling: texture coated board- varnished  
Slide-surface: 20mm PE- white- screwed from below

## LONDON GAP JERSEY BARRIER

Order-Nr. LGJERSEY3

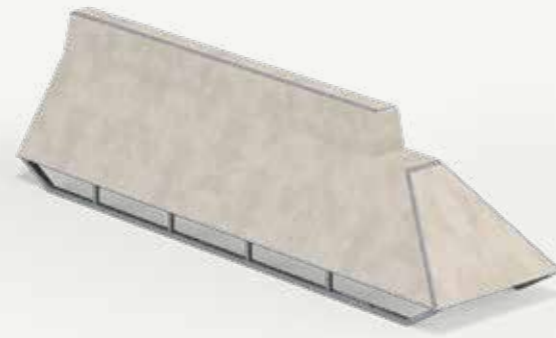

Size: 4,1 x 1,1 x 1,1m (l x w x h)



Profile: One piece Box 0,2m wide  
Material: hot zinc dipped steel frame  
Side panelling: texture coated board- varnished  
Slide-surface: 20mm PE- white- screwed from below

## CURVED BOX 6 AND 9M

Order-Nr. C605L / C905L



Size: 6 (or 9) x 0,5m (l x h)



Profile: Two (or three) parted Box  
Material: hot zinc dipped steel frame  
Side panelling: on the inside 4mm Dibond- white- riveted,  
on the outside 1,5mm steel sheet- varnished- white

## S BOX/ RAIL 12M

Order-Nr. S1205L / S1203L

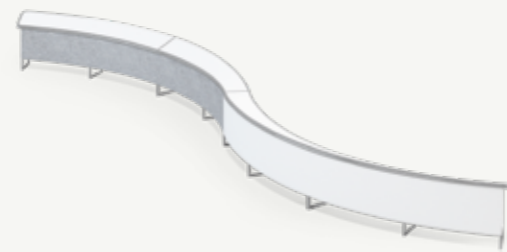

Size: 12 x 0,5m (l x h)



Profile: four parted Box  
Material: hot zinc dipped steel frame  
Side panelling: on the inside 4mm Dibond- white- riveted,  
on the outside 1,5mm steel sheet- varnished- white

Profile: four parted Big Pipe  
Material: powder coated steel frame- black  
Side panelling: on the inside 4mm Dibond- white- riveted,  
on the outside 1,5mm steel sheet- varnished- white





## WATERFALL

Order-Nr. WF1003L



Size: 10 x 0,5 (l x h)



Profile: Two parted big pipe rail  
Material: powder coated steel frame - black  
Side panelling: 4mm dibond on both sides- white- riveted



## QUAD KINKED

Order-Nr. QK1003L

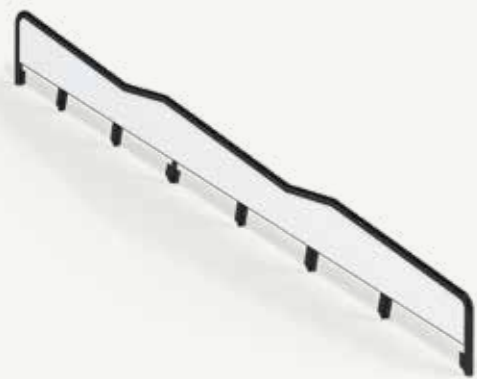

Size: 10 x 0,5 (l x h)



Profile: Two parted big pipe rail  
Material: powder coated steel frame - black  
Side panelling: 4mm dibond on both sides- white- riveted

## TANK FLAT

Order-Nr. TANK3/ TANK6/ TANK9



Size: 3 (6 or 9) x 0,6m (l x ø)



Material: varnished steel- all standard RAL colors feasible without surcharge  
Extras: incl. skids for easier handling in the snow

## TANK KINKED

Order-Nr. FDTANK7



Size: 7 x 0,6m (l x ø)



Material: varnished steel- all standard RAL colors feasible without surcharge  
Extras: incl. skids for easier handling in the snow

## TANK DOUBLE KINKED

Order-Nr. DFDTANK9



Size: 9 x 0,6m (l x ø)



Material: varnished steel- all standard RAL colors feasible without surcharge  
Extras: incl. skids for easier handling in the snow





## PEAK

Order-Nr. PEAK



Size: 2,5 x 2,5m (l x ø), One parted pyramid/ cone

Material: varnished steel- all standard RAL colors feasible without surcharge

Extras: incl. skids for easier handling in the snow

## LOLLIPOP

Order-Nr. LOLLIPOP



Size: 3m high, sphere 1m ø, Two parted jib sphere on steel pole

Material: hot zinc dipped steel frame, sphere: varnished GRP, Color of the sphere: all standard RAL colors possible without surcharge

## SCOOP

Order-Nr. SCOOP

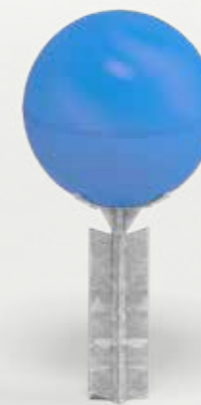

Size: sphere 1m ø, Two parted jib sphere on steel feet

Material: hot zinc dipped steel frame, sphere: varnished GRP, Color of the sphere: all standard RAL colors possible without surcharge

## MUSHROOM

Order-Nr. MUSH2



Steel jib-cupola with 2m diameter

Color: all RAL colors feasible without surcharge





## STAIRS

Order-Nr. STAIRS



Size: 4 x 1,25m (l x w)

Material: varnished wooden construction, with black PE edge protection profile on the edges of the stairs

## FLAT BRIDGE

Order-Nr. SPFLBRIDGE

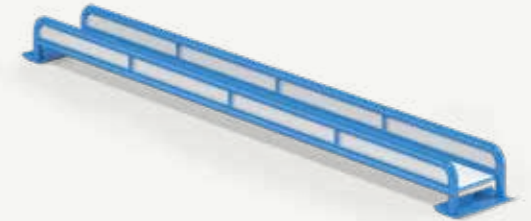

Size: 8 x 0,85 x 1m (l x w x h)



Profile: One Piece big pipe bridge  
 Material: varnished steel frame- all standard RAL colors feasible without surcharge  
 Side panelling: both-sided Polycarbonate  
 Slide surface: 20mm PE- white- screwed from below

## RAINBOW BRIDGE

Order-Nr. SPRABRIDGE

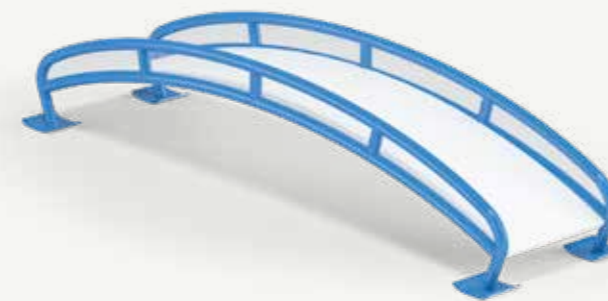

Size: 8 x 0,85 x 1m (l x w x h)



Profile: One Piece big pipe bridge  
 Material: varnished steel frame- all standard RAL colors feasible without surcharge  
 Side panelling: both-sided Polycarbonate  
 Slide surface: 20mm PE- white- screwed from below

## AFRAME BRIDGE

Order-Nr. SPAFBRIDGE

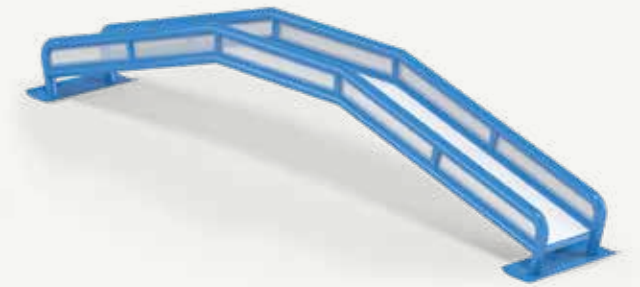

Size: 8 x 0,85 x 1m (l x w x h)



Profile: One Piece big pipe bridge  
 Material: varnished steel frame- all standard RAL colors feasible without surcharge  
 Side panelling: both-side Polycarbonate  
 Slide surface: 20mm PE- white- screwed from below



# Custom Made

Every action sports park is individual, just like you and your customers. Fits perfectly together? We think so too! That is why we offer the possibility to brand every snowpark individually in compliance with the customers CD. The individual elements of a snowpark are perfect as branding options. But that is not enough for us, we go one step further and offer you the possibility to create our own theme world in order to stand out. Only your fantasy is the limit and your guests will be amazed when they enter your own snowpark theme world.

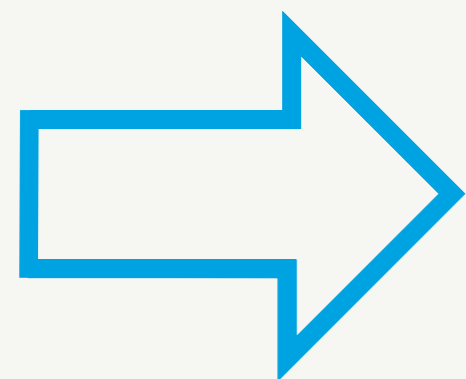
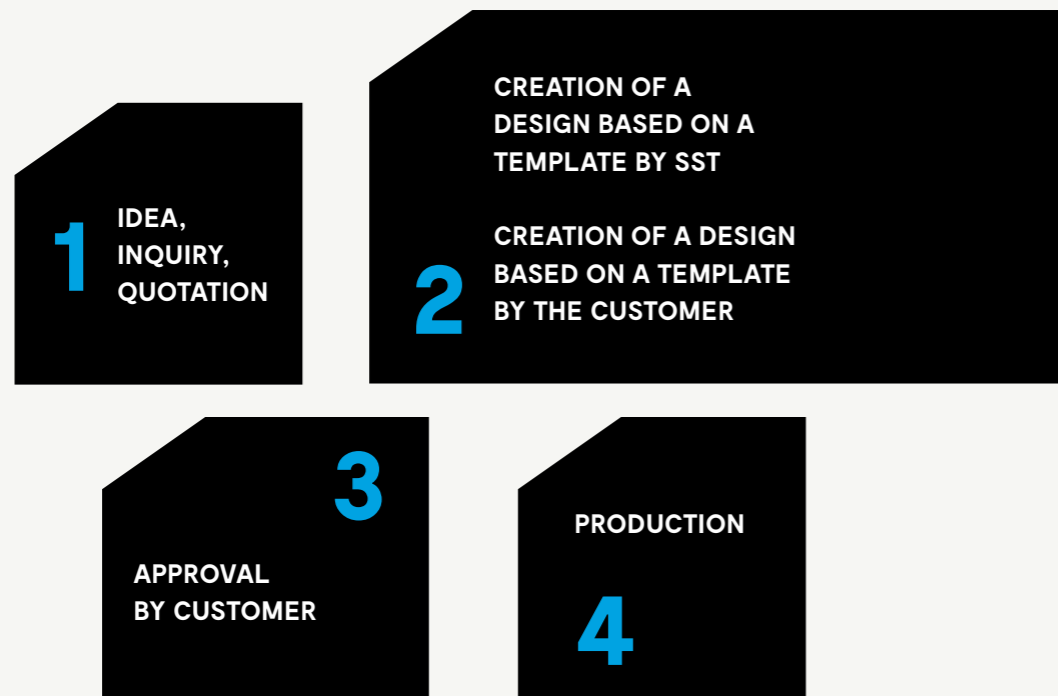

**your individual Schneestern product**

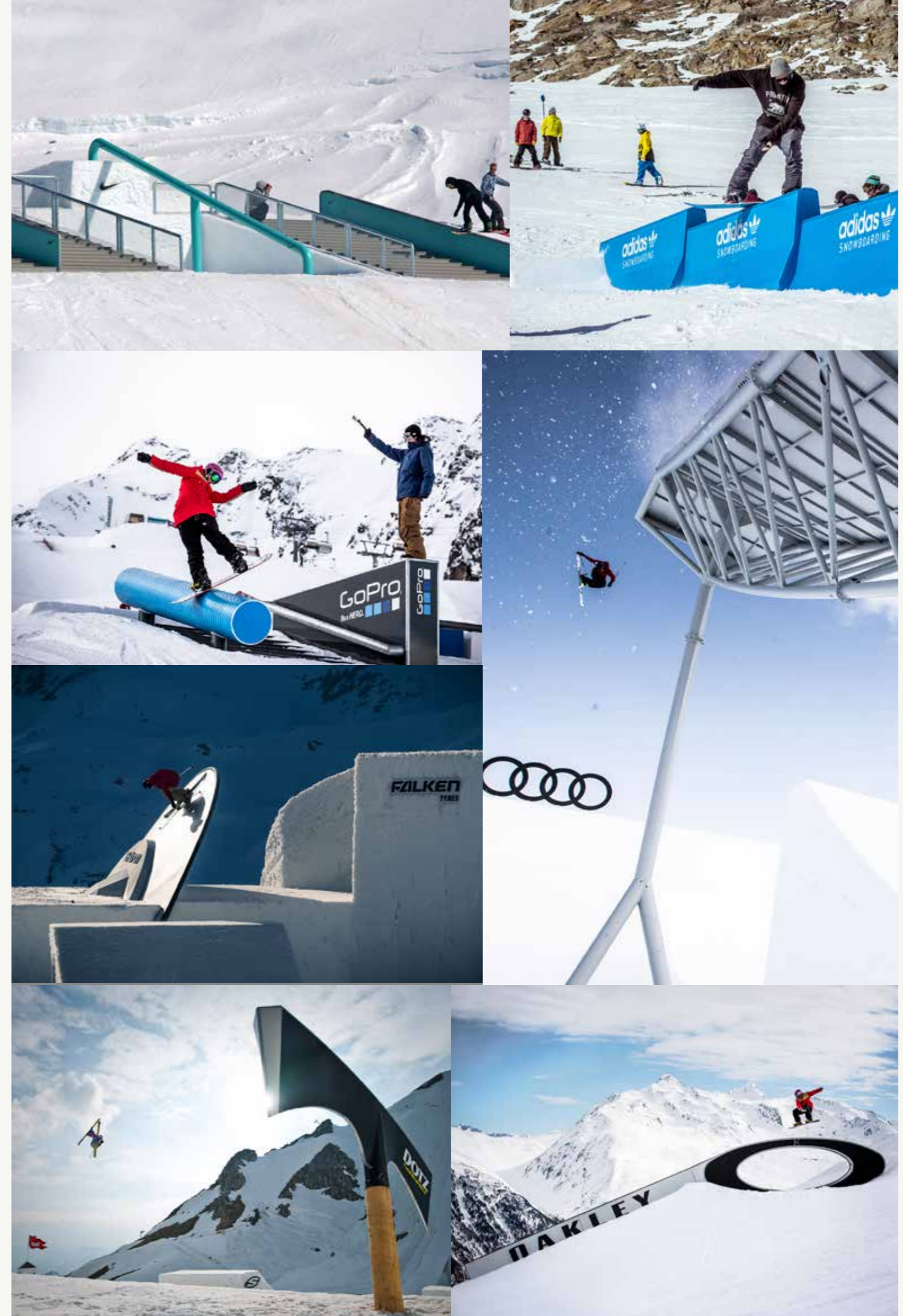

Obstacles for Skischools

Funline

Attraction

Freestylepark

Add Ons



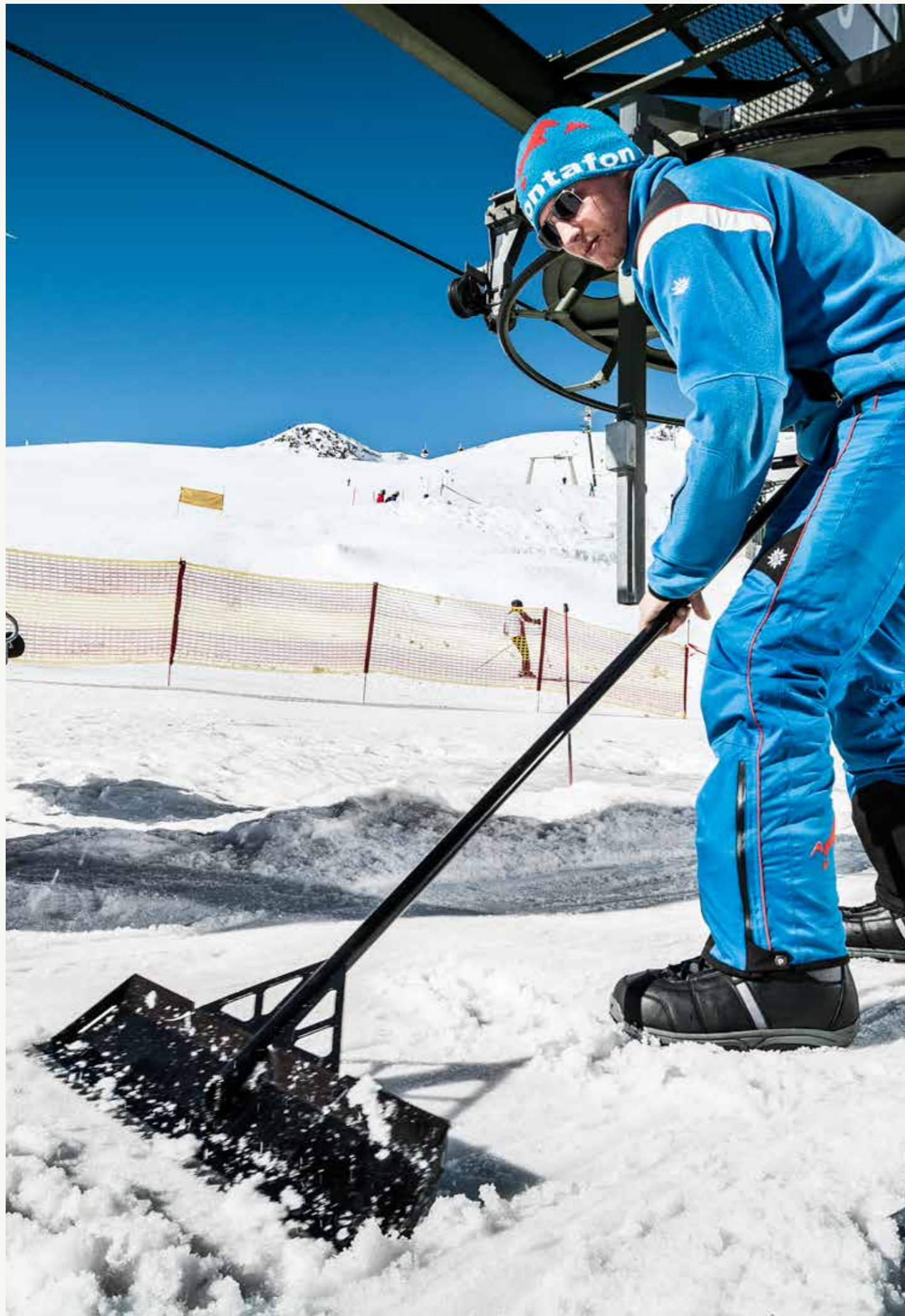

Add Ons



## PARK SHAPER

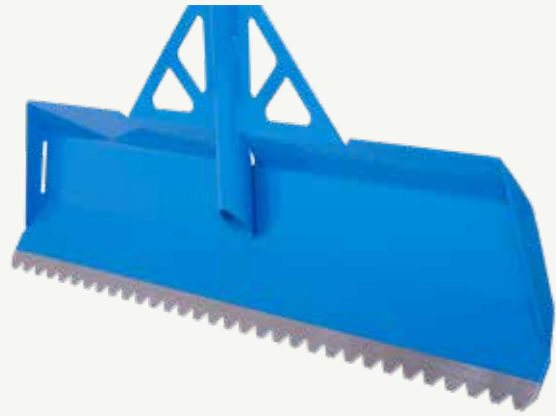

Size: 1,8 x 0,65m (l x w)

Material: torsion resistant construction out of stainless premium steel, precision lasered and powdercoated  
Extras: blade incl. side wings for better snow transport, shaft incl. T-handle

## VERTSHOVEL



Size: 2,15 - 4 x 0,3m (l x w)

Material: Lasered and steel pearl shot premium steel blade, anodized telescopic shaft  
Extras: CNC milled blade-socket for rotary blade with edged and spiky blade

## TRANSPORTER



Size: 1,80 x 0,76 m (l x w)

Material: stainless premium steel blade, light aluminum with anodized shaft and handle  
Extras: CNC milled blade-socket, big shovel blade to move more snow

## VERTSHOVEL MIT GELENK

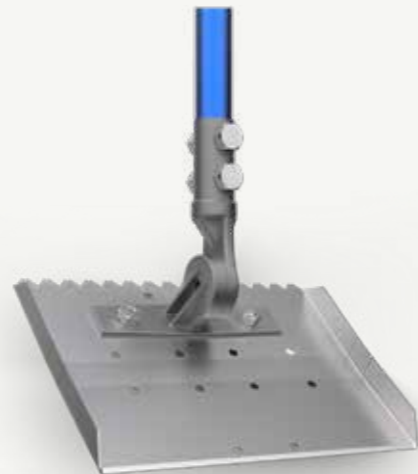

Size: 2,15 - 4 x 0,3m (l x w)

Material: stainless premium steel blade, light aluminum with anodized shaft and handle  
Extras: Fresno-Joint with quick-release for adjustment of the blade angle, CNC milled blade-socket for precise contour cutting





# Branding

A bid old sticker will do. Of course not! For us, branding means that we use the available advertising space on the obstacles individually, depending on your wishes and budget. For that we use a variety of advertising technique.

- **Varnishing**

- **full surface adhesive**

- **full surface digital print**

- **printed tarp**

- **SKG-printed sliding surface**

- **Playtec**

- **diverse coloured plastics**

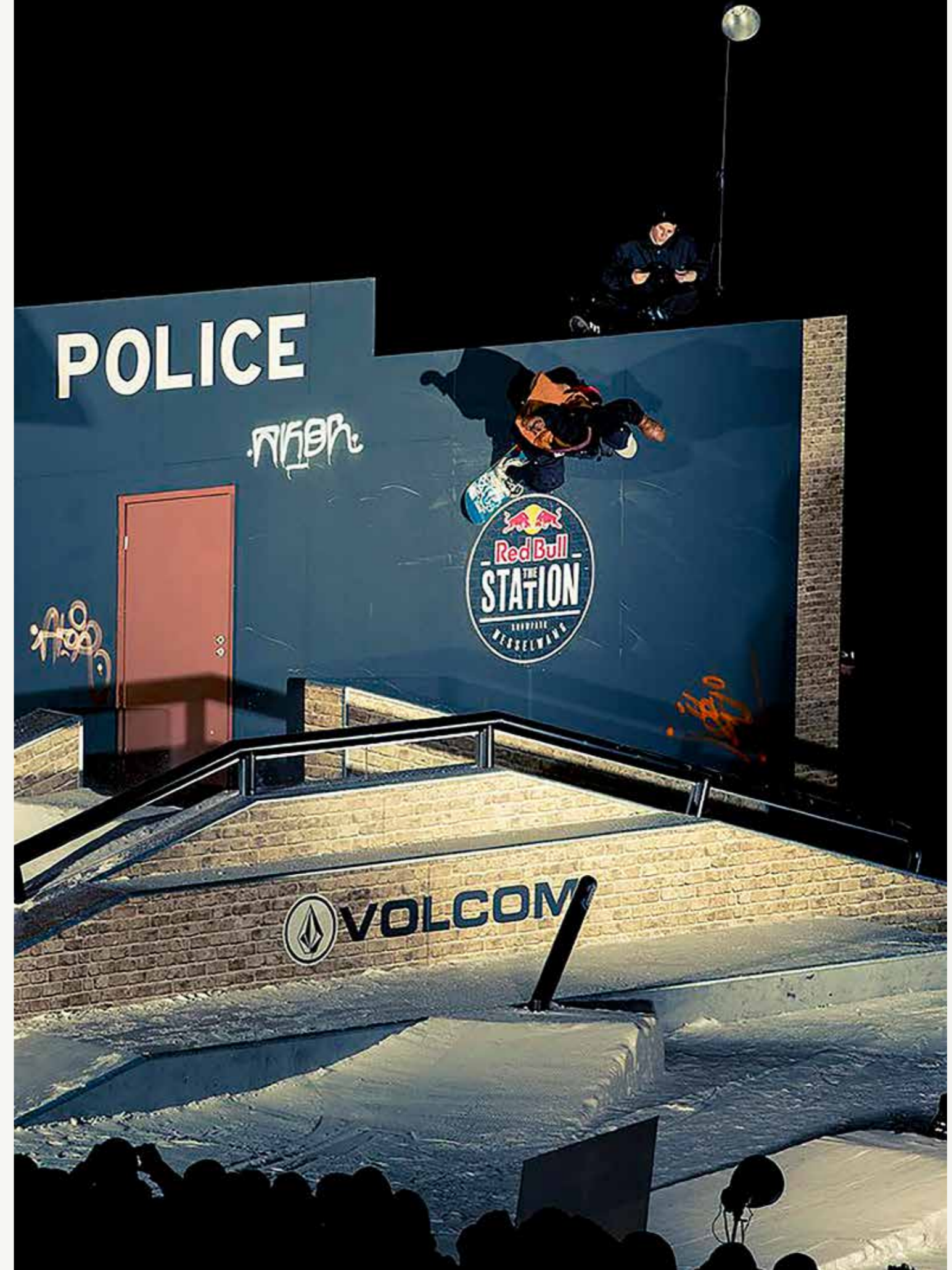



# Replacement parts

## HANDS FOR HIGH FIVE/LOW FIVE/ SOUND PRODUCTS

Order-Nr. HIGH FIVE HAND



## HANDS FOR ROTARY CHARACTERS/ SOUBD PRODUCTS

Order-Nr. SLOPY HAND



## TRANSPORT SNOW TUNNEL

Order-Nr. VTTRANSYS



## BATTERIES WITH AND WITHOUT CASE FOR ALL SOUND ELEMENTS

Order-Nr. BATTERY

with case



Price on Request:

## INDUSTRIAL BEARING

Order-Nr. DREHMECHANISMUS



## ON AND OFF SWITCH

Order-Nr. EIN- UND AUSSCHALTER

## CONNECTION MEANS

Order-Nr. VERBINDUNGSMITTEL

## SENSORS FOR SOUND ELEMENTS

Order-Nr. SENSOREN FÜR SOUND ELEMENTE

## PLUGS

Order-Nr. STECKER

## STOPS FOR INDUSTRIAL BEARINGS

Order-Nr. ANSCHLÄGE FÜR DREHMECHANISMEN

## SPEAKERS FOR SOUND ELEMENTS

Order-Nr. LAUTSPRECHER 45W



## CABLE FOR SOUND ELEMENTS

Order-Nr. KABEL



# network of partners

We rely on a strong network to take advantage of synergies and promote action sports together. Therefore we are proud members and networkers of the following partnerships.

## MEMBER OF:

VDS: Verband Deutscher Seilbahnen



HWK: Handwerkskammer für Schwaben



IHK: Industrie- und Handwerkskammer



## COOPERATIONS:

Pistenbully



Zeppelin Rental



Festool



Helly Hansen



# contact



+49 831 960 886 10



snow@schneestern.com



Schneestern GmbH & Co KG  
Werner v. Siemens Str. 47  
87471 Durach · Germany

# imprint

t: +49 (0) 831-960886-10    Schneestern GmbH & Co. KG  
f: +49 (0) 831-960886-40    Werner-von-Siemens-Strasse 47, D-87471 Durach

Schneestern GmbH & Co. KG · Rechtsform: Kommanditgesellschaft · Sitz: Durach · Registergericht: Kempten HRA 8156 ·  
Persönlich haftende Gesellschafterin: Schneestern Management GmbH · USt-IdNr: DE 254363841 ·  
Geschäftsführer: Dirk Scheumann, Kai Siebdrath · Bank: Raiffeisenbank Kempten · IBAN: DE62 7336 9920 0100 2037 85 · BIC: GENODEF1SFO

# more catalogues



SNOW  
Parks

BIKE

Download all  
our catalogs on  
our Website!

# photographers

Beat Schwiersch  
Steffen Vollert  
Simon Abele  
Falch Photography  
Felix Pirker  
Roland Haschka  
Hannes Mautner  
Martin Erd  
Daniel Ausweger  
Adam Johnston  
Fabian Braitsch

Florian Jaeger  
Alexandra Engels  
Stefan Eigner  
Cyril Müller  
Markus Fischer  
F-Tech  
Matthias Schwarz  
Bernie Kofler  
Ethan Stone  
Lorenz Holder  
Eze Urrets



**action sports** engineered